

1008140230

TA-23

Industrial Handset for Turbine with PTT



- ✓ Rugged handset for Industrial application
- ✓ PTT-key for simplex operation in extremely noisy environments
- ✓ Noise-cancelling microphone
- ✓ High quality digital background noise reduction*
- ✓ HD-voice compatible*
- ✓ IP Rating: IP66
- ✓ Designed for Turbine Industrial Intercoms

*when used with Turbine Industrial intercoms

ICX ICX-AlphaCom  Exigo  IP66

Description

The TA-23 Industrial Handset for Turbine intercoms is a rugged, high quality handset designed for industrial and military use. The slim profile offers ease-of-use in hard-hat areas as it slips under helmets and/or hearing protection. The TA-23 offers a side-mounted PTT for simplex operation in extremely noisy environments. Used with Turbine industrial intercom stations, the active noise-reduction features offer exceptional audio quality and intelligibility. A hanger is included with the delivery.

Technical Dimensions

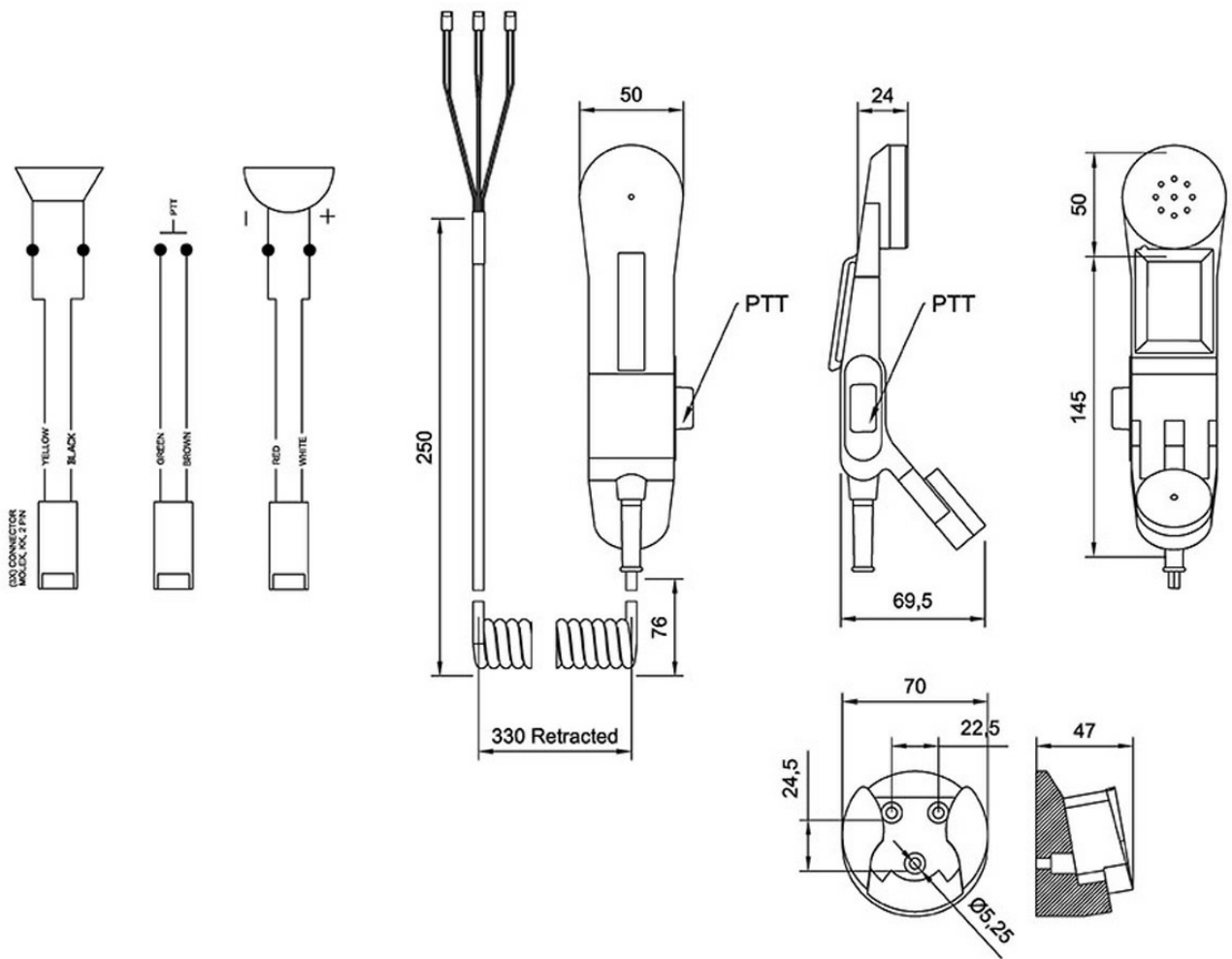

Specifications

MECHANICAL

Dimensions (WxDxH)	200 x 70 x 50 mm
Weight	310 g
Cable Length	1.0 m (contracted) / 3.5 m (extended)

ENVIRONMENTAL

Operating Temperature	-40°C to +65°C
Ingress Protection (IP)	IP66

ACOUSTICAL

Frequency Response	200 - 7000 Hz
--------------------	---------------

Used With



TFIE-1

IP and SIP Intercom

Item Number: 1008122010



TFIE-2

IP and SIP Intercom

Item Number: 1008122020



EAPII-1

Exigo Industrial Access Panel,
1 Button

Item Number: 1023201201



EAPII-6

Exigo Industrial Access Panel,
6 Buttons

Item Number: 1023201206



TFIE-6

IP and SIP Intercom

Item Number: 1008122060