



1008140180

## TA-18

### Turbine Compact Flush-Mount Back Box

- ✓ Back Box for flush mounting of all Turbine Compact Stations
- ✓ Makes the front faceplate of the station flush with the wall surface
- ✓ No screw holes, the backbox is simply glued or cast in place

---

## Description

Flush mount backbox for Turbine Compact stations

## Technical Dimensions

### FRONT VIEW

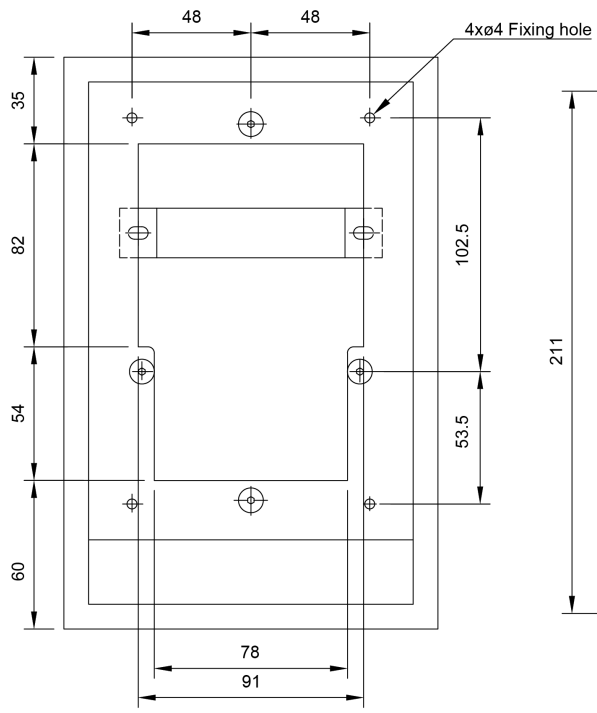

### SIDE VIEW

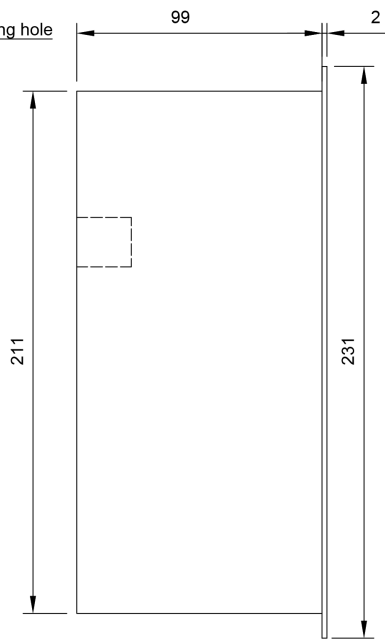

### REAR VIEW

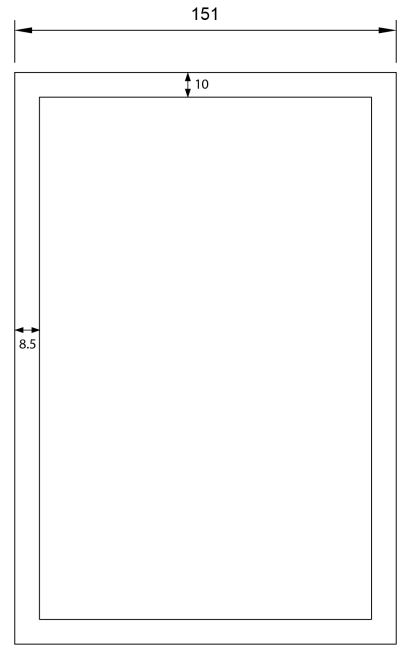

### BOTTOM VIEW

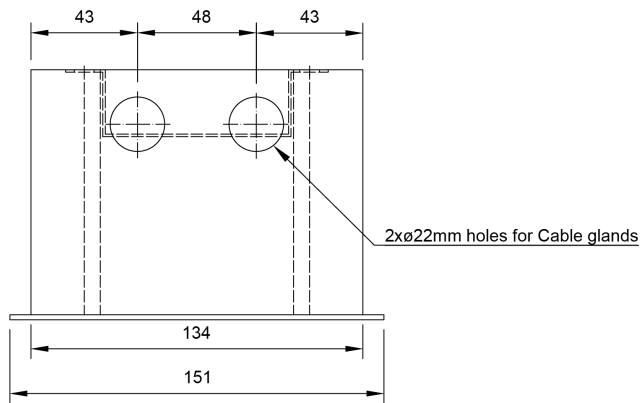

All dimensions in mm

# Specifications

Dimensions (WxHxD):	151 x 231 x 101 mm
Weight:	1.5 kg
Material:	Mild Steel Black Paint

## Used With



TCIS-1

IP and SIP Intercom



TCIS-2

IP and SIP Intercom



TCIS-3

IP and SIP Intercom



TCIS-4

IP and SIP Intercom



TCIS-5

IP and SIP Intercom



TCIS-6

IP and SIP Intercom



TCIA-2

Analog over IP Intercom



TCAS-1

Analog Intercom



### TCAS-2

Analog Intercom



### TCAS-3

Analog Intercom