

4000086829



## BIVEP-6T

Projector speaker 6 watt

 Bi-directional

Onboard communication

## Description

-  Double faced projector w/ transformer for accommodations area
-  Ideal for P.A. announcements and background music applications
-  To be used together with 70/100V line amplifier

The BIVEP-6T is a general purpose projector to be used on 70/100 V lines. The projector is bidirectional and disperses audio in both directions. This feature makes this speaker very well suited for corridors and other applications where audio has to be evenly distributed.

# Technical Dimensions

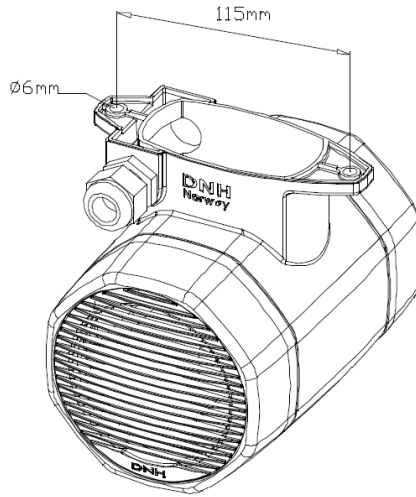
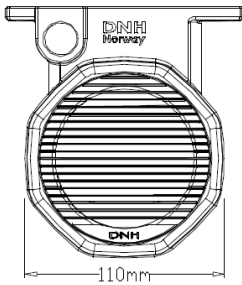
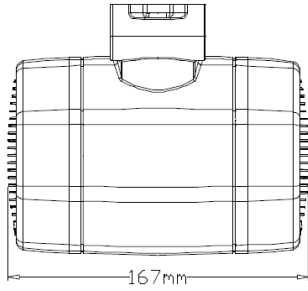

1xM20 blinding plug  
1xM20 gland

## Circuit diagram

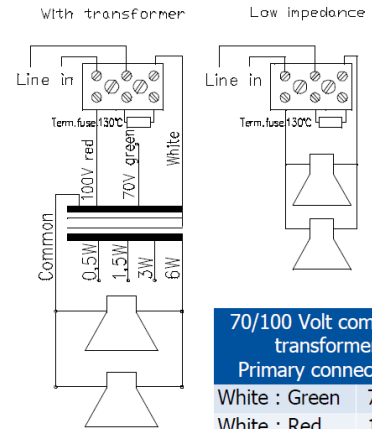

70/100 Volt combined transformer	
Primary connections	
White : Green	70 V
White : Red	100 V
Secondary nominal tapings	
C : 6	6,0 W
C : 3	3,0 W
C : 1,5	1,5 W
C : 0,5	0,5 W

# Specifications

## GENERAL

Material / Color	ABS / RAL 7035
Dimensions (LxDxH)	167mm x 120mm x 120mm
Mounting	Foot bracket
Termination	Ceramic screw terminals
Weight	0.94 kg
Rated / Max power	6 W / 10 W
SPL 1W / 1 m	87 dB
SPL rated power	94 dB
Effective frequency range	150 - 20000 Hz
Dispersion (-6dB) 1kHz / 4kHz	360° / 2x70° (bidirectional)
IP-rating	44
Environmental Condition	Protected