



1020600787

## VMP-36-PEL-Ad

Headset with boom mic, headband, and 10m cable for VMP Station

Base product: VMP-36-PEL-A

Includes: 3005020067 - Modification cable kit with diode for [VMP-stations](#) - See the Documents tag for the modification description

- ✓ Headset for direct connection to a VMP station
- ✓ Switchbox w/ M-button and belt clip
- ✓ Excellent noise performance
- ✓ High attenuating ear shells
- ✓ Standard with 10 meter cable



IP54



Onboard communication

## Description

The VMP-36-PEL-A headset brings hearing protection and communication in noisy environments into a new level of performance with newly designed speakers and microphone.

The dual cup give a modern and slim look and is specially designed to provide excellent noise attenuation.

## Applications:

The VMP-36-PEL-A headset can enhance communication in noisy environments and other workplaces, where the workers need to be connected to their 2-way handheld or fixed systems throughout the day to help facilitate frequent contacts with co-workers.

## Functionality (together with VMP station):

In the headset OFF position, the station's loudspeaker and microphone are working as normal. The incoming audio is also heard in the headset, but the headset microphone is not enabled. (P.S: if standing near the station, the station microphone picks up the user's voice. This is easily mistaken to be coming from the headset)

In the headset ON position, the station's loudspeaker still works, but the integrated microphone is muted and the headset microphone is enabled. (P.S: In the process of switching to ON position, the dial tone is not triggered automatically - that aspect of the station works as normal. The dial tone appears only after starting to type the extension number.)

Use the headset PTT button (M-button) to talk from the headset when in a conversation. This will automatically activate simplex mode. Return to duplex mode by briefly reactivating the PTT button.

Switch back to OFF position and terminate the call by pressing the "C" key on the station

## Technical Dimensions

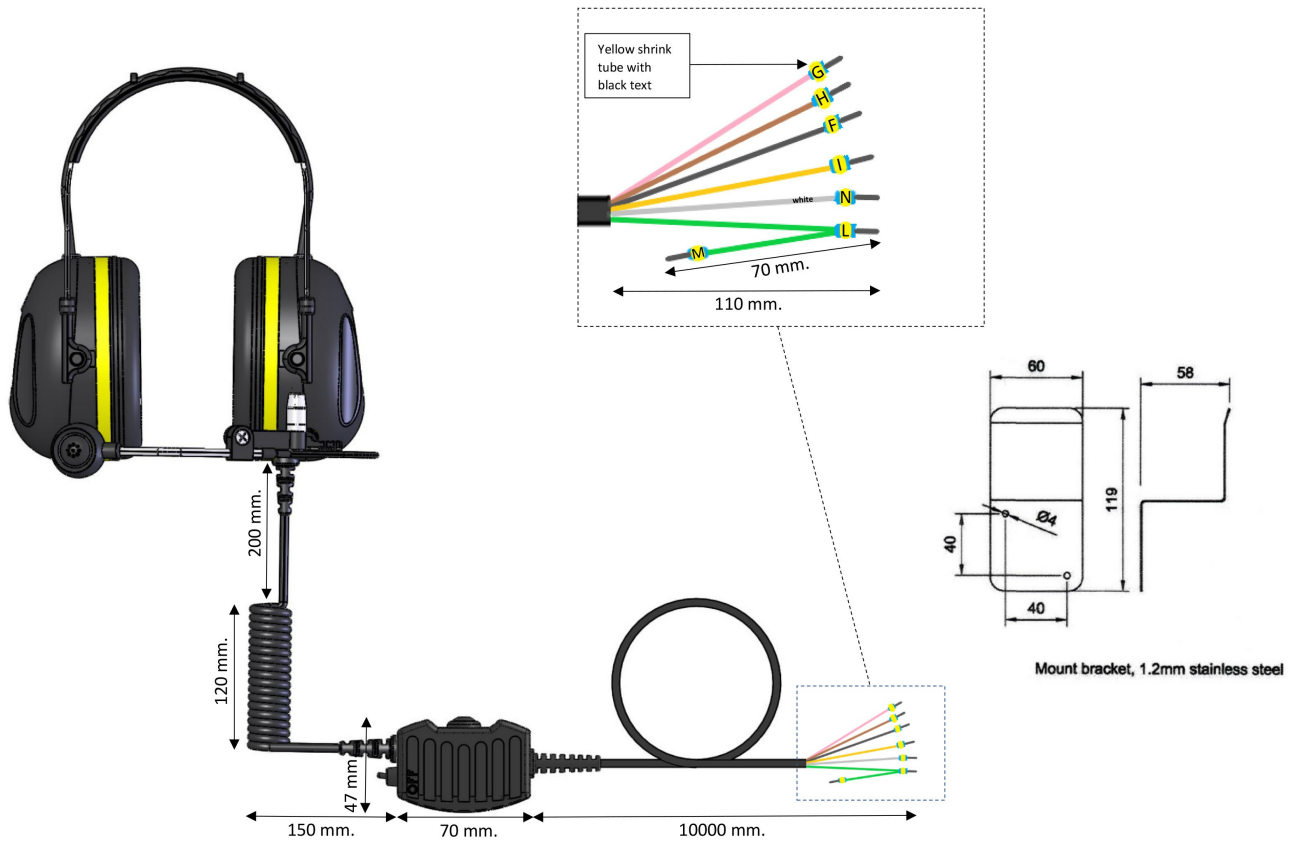

# Specifications

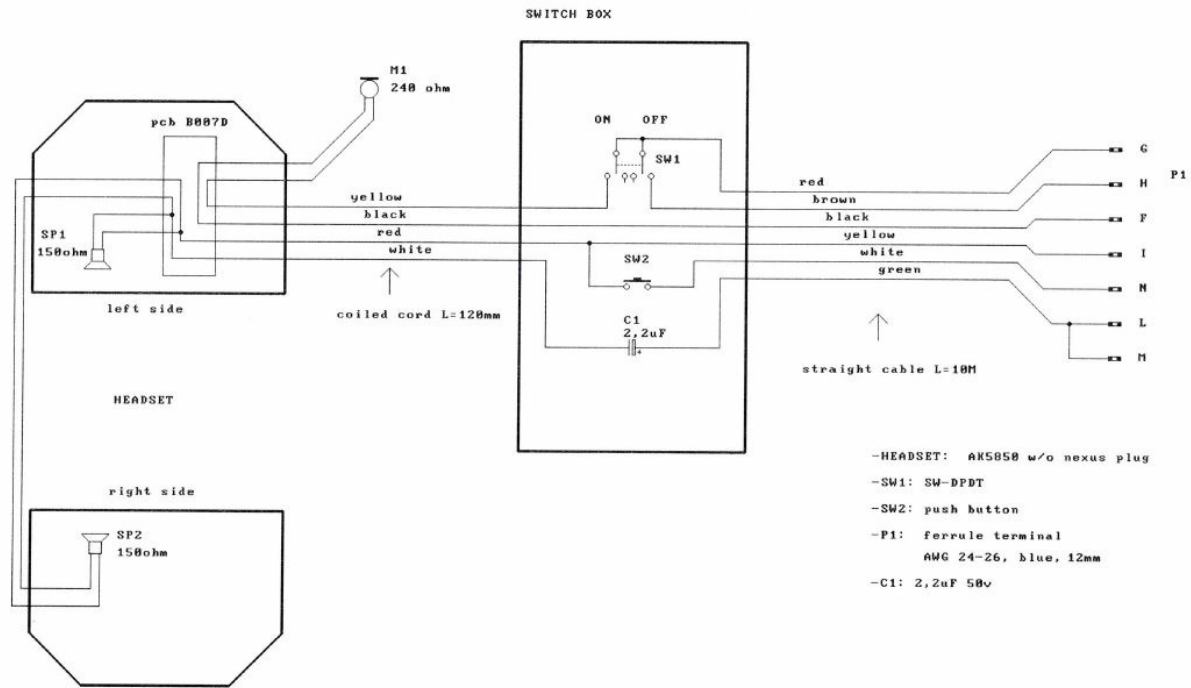

## GENERAL

Termination	Flying leads/ferrules, prepared for screw terminals
Microphone	20,5 mm. dynamic noise cancelling, 240 Ohm+- 30 %, sensitivity -57 dB+-3 dB, 0 dB=1v/pa at 1kHz, frequency response: 50Hz-6KHz.
Earphone/Speakers	27 mm. diameter, 150 Ohm+-15 %, Parallell connection, frequency response: 50Hz-10KHz.
Temperature	-40 to +60 degrees C
Storage Humidity	< 90%
Protection	IP-54 (When worn)
Attenuation rating (HML)	H=32 dB / M=28 dB / L=20
Attenuation rating (SNR)	30 dB
CE Certificate no.	12151RHS01
Dimension (HxD)	Approximately 250 x 150 mm. (adjustable).
Weight	0.4 kg
Colour	Black/Yellow
Manufacturer	Zenitel (A-kabel)
Cable	10m

## Accessories



Spare Boom Microphone for Headset

Spare Boom Microphone for all A-Kabel type Headsets

Item Number: AK6070



Hygiene kit for Headset

Hygiene kit for Headset

Item Number: AK6501



Headset Stowage Bracket

Headset stowage Bracket for Wall mounting

Item Number: 3006090494



Spare Switchbox w/cable for VMP-36-PEL-Ad

Item Number: 3006600054



AK6070T Throat microphone for all A-kabel type Headsets

Dynamic Throat Microphone for Headset

Item Number: 3006090490

Used With



Light Industrial Master Station

Item Number: 1007080000



Industrial Master Station

Heavy Duty

Item Number: 1007086000



VMP-530

Main Station Waterproof

Item Number: 1020600305



VMP-503

Main Station With Loudspeaker

Item Number: 1020600315