

2310111201

NTX2I0R00A NTX 35mm Thermal Camera

Thermal Camera



- ✓ Digitally signed firmware
- ✓ Uncooled VOx microbolometer
- ✓ 35mm lens
- ✓ 336 x 256 resolution
- ✓ Quick connectors
- ✓ Built-in modular support
- ✓ POE+
- ✓ IP66, IP67, IP68, IP69

ONVIF ONVIF Conformant  IP66  IP67  H.264

Description

The NTX2I0R00A NTX 35mm Thermal Camera provides an efficient and preventative surveillance system in the most critical environmental conditions. The NTX thermal camera offers temperature detection based on the 4 central pixels of the image. As well as this, the radiometric functions offer the option to set a temperature limit, beyond which an alarm will be raised.

These functions are necessary where fire prevention is required, or in applications such as monitoring critical equipment where the ability to identify something quickly and accurately is needed, to prevent problems and keep intervention times to a minimum.

NTX2I0R00A NTX 35mm Thermal Camera

The thermal camera can export all the data necessary for a centralized management of video feeds, data and alarms, and make it available to VMS via the ONVIF Profile T, Profile S and Profile Q communication protocols.

It is made entirely from electropolished AISI316L stainless steel and stands out thanks to its compact design and light weight. This, and the fact that it can be connected quickly, makes installation and maintenance easier. The modular support for wall, ceiling or parapet is supplied as standard.

The NTX2I0R00A NTX 35mm Thermal Camera has obtained Lloyd's Register Marine Type Approval certification for the maritime sector. The fact that the NTX is extremely sturdy and of high quality means it is ideal for the most demanding applications in the maritime industry.

Technical Dimensions

The indicated measurements are expressed in millimetres.

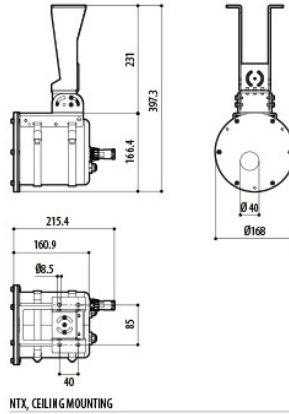
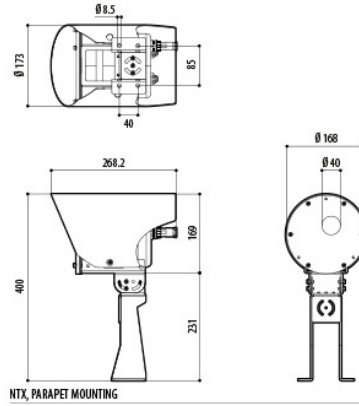
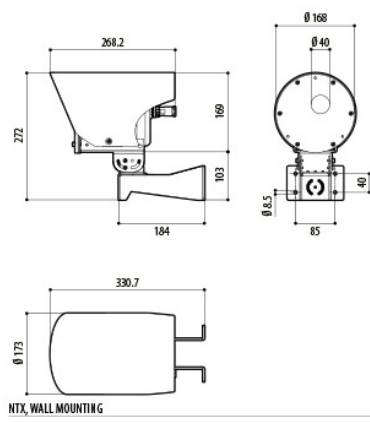

Specifications

GENERAL

Radiometric Analysis	definition of a specific area
Radiometric Alarm Activation	If the temperature is over the threshold set, under the threshold set, between two thresholds set or outside the two thresholds set.

MECHANICAL

Material	AISI 316L stainless steel with slot for safety chain
Unit weight	4.9kg (fastening support included) 4kg (fastening support not included)

HOUSING WINDOW (GERMANIUM WINDOW)

Thick	1.5mm
External treatment	antiscratch (Hard Carbon Coating - DLC), antireflection
Internal treatment	antireflection
Spectral range	from 7.5µm up to 14µm
Medium transmittance (from 7.5µm up to 11.5µm)	91.2%
Medium transmittance (from 11.5µm up to 14µm)	80.9%

ELECTRICAL

Supply voltage / Current consumption	24Vac, 1.32A, 50/60Hz 24Vdc, 0.9A PoE+ (IEEE 802.3at)
Power consumption	21W

NETWORK

Ethernet connection	100 Base-TX
Connector	RJ45

CYBERSECURITY

	Digitally signed firmware
	Password restricted access (HTTP digest)
	Support of various user access levels
	Control of accesses IEEE 802.1X
	HTTPS cryptography using TLS1.0, TLS1.1, TLS1.2 and TLS1.3
	Centralized certificate management
	Complies with ONVIF Security Service specifications

I/O INTERFACE

I/O Alarm Board	Input for remote reset: 1
	Relay output: 1 (1A, 30Vac/60Vdc max)

VIDEO ENCODER

Communication protocol	ONVIF, Profile Q, Profile S and Profile T, ONVIF Thermal Service
Device configuration	TCP/IPv4-IPv6, UDP/IPv4-IPv6, HTTP, HTTPS, NTP, DHCP, WSDISCOVERY, DSCP, IGMP (Multicast), SOAP, DNS
Streaming	RTSP, RTCP, RTP/IPv4-IPv6, HTTP, Multicast
Video compression	H.264/AVC, MJPEG, JPEG, MPEG4
QoS	Differentiated DSCPs for streaming and device management
Streams	3 Independent video streams
Selectable frame rate	from 1 to 30 images per second (fps)
General Video	web server motion detection

ENVIRONMENT

Installation	Indoors and outdoors
Operating temperature	from -40°C up to +60°C
Surge immunity	up to 1kV line to line, up to 2kV line to earth (Class 3)
Relative humidity	from 5% up to 95%

CERTIFICATIONS

Electrical safety (CE)	EN60950-1, IEC60950-1, EN62368-1, IEC62368-1
Electromagnetic compatibility (CE)	EN61000-6-4, EN50130-4, EN55032 (Class A), FCC Part 15 (Class A), ICES003
Outdoor installation (CE)	EN60950-22, IEC60950-22
IP protection degree (EN60529)	IP66, IP67, IP68 (2h30min, 2m, IP69
UL certification	cULus Listed, TYPE 4X, TYPE 6P
EAC certification	Yes
NDAA-compliant	Yes
Lloyd's Register Marine Type Approval	Test Specification Number 1 (ENV1, ENV2, ENV3, ENV5)
Electromagnetic compatibility	EN60945
Salty fog resistance	EN60068-2-52
	*Tested at 70°C for 16 hours in compliance with EN60068-2-2

DETAILS

Image Device	Uncooled VOx microbolometer
Interpolated resolution	720x480
Pixel dimensions	17µm
Spectral response - long wave infrared (LWIR)	from 7.5µm to 13.5µm
Internal shutter (only for sensor compensation)	Video stop < 1sec.
Digital Detail Enhancement (DDE)	yes
Digital zoom	2x, 4x
Image updating frequency	7.5fps
Image updating high frequency	30fps
Scene range (High Gain)	-40°C ÷ +160°C
Scene range (Low Gain)	-40°C ÷ +550°C
Horizontal field of view	9,3°
Vertical field of view	7,1°
F-number	F/1.2
Thermal sensitivity (NETD), standard camera	< 50mK at f/1.0
Thermal sensitivity (NETD), radiometric camera	< 30mK at f/1.0
Person (detection / recognition / identification)	1280m / 320m / 160m
Car (detection / recognition / identification)	3850m / 950m / 295m