



PUBLIC ADDRESS  
AND VOICE ALARM  
SOLUTIONS



# TRUSTED VOICE. UNCOMPROMISING CLARITY.

Your trusted communication partner,  
helping keep people secure, informed, and connected.

# Unified critical Communication

for safety, security,  
and operations

With more than **125 years of experience** in critical communication solutions, Zenitel is a trusted communication partner, helping keep people secure, informed, and entertained.

Zenitel's Unified Critical Communication (UCC) approach brings together intercom, Public Address, Voice Alarm, and IP Speakers into one cohesive communication ecosystem, helping organizations move from siloed systems to coordinated operational response.



# Truly a unique player in the market

When it comes to Public Address and Voice Alarm solutions, Zenitel delivers trusted reliability and exceptional audio quality. What sets us apart is our ability to unify a diverse portfolio of communication solutions under a single platform — **Zenitel Connect Pro**.

This makes it easier for system integrators and installers to deploy, integrate, and maintain our products. With multiple integration possibilities towards other security and safety systems, Zenitel's PAVA solutions are well suited for both new installations and upgrade projects.



## Zenitel Public Address and Voice Alarm Portfolio



IP SPEAKERS

Zenitel VAIA

INTEGRA

VIPEDIA

## Zenitel Intercom Portfolio



Zenitel Connect Pro

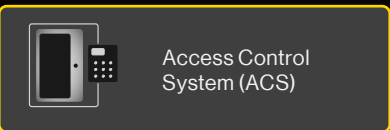

Access Control System (ACS)

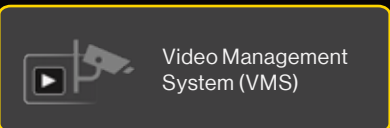

Video Management System (VMS)

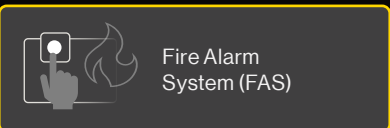

Fire Alarm System (FAS)

# Scalable PAVA Solutions for every application

“

## IP SPEAKERS

Ideal choice for smaller deployments such as retail stores, or applications requiring granular zone selection and control, such as staircases.

”

S

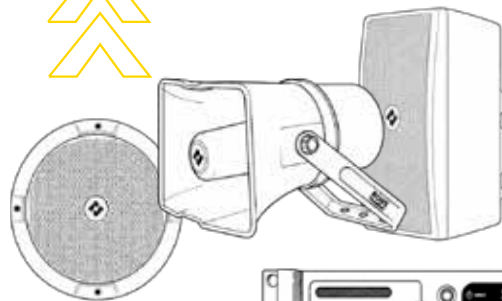

“

## Zenitel VAIA

Zenitel VAIA is a compact, all-in-one Public Address and Voice Alarm system, certified to EN54. Designed for mid-sized deployments, Zenitel VAIA combines performance, reliability, and flexibility with fast, straightforward installation.

”

M

“

## INTEGRA

Ideal choice for low-complexity wall-mount solution with de-centralized architecture.

”

L

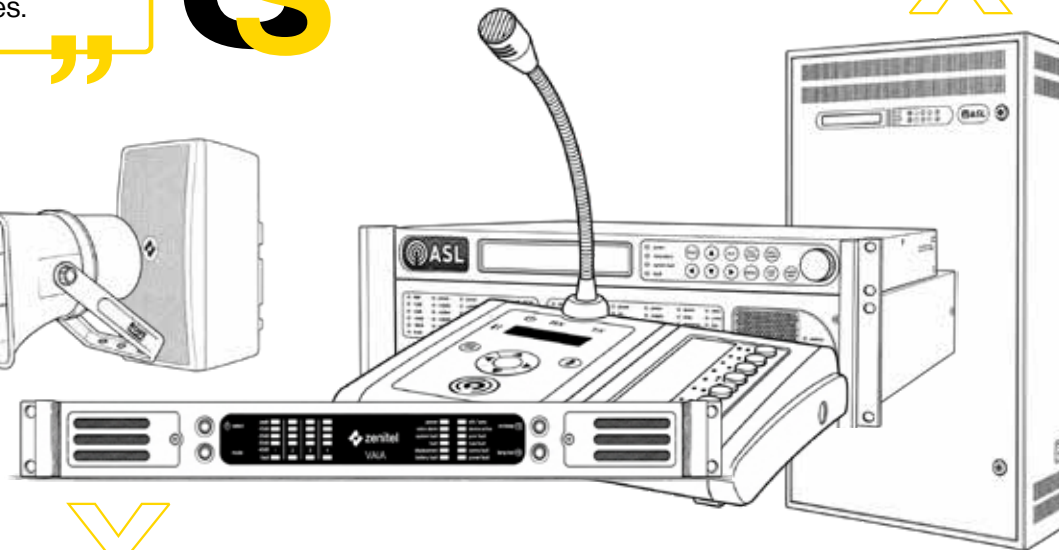

“

## VIPEDIA

Ideal choice for larger deployments such as airports and industrial plants or applications where flexible or evolving output power needs are key.

”

X

# We Enhance Clarity Where It Matters Most

Our PAVA solutions are designed to deliver exceptional audio performance for all types of announcements and background music. Powered by patented\* amplifier technology, our PAVA product lines feature professional quality DSP, full-range frequency processing, and uncompressed native audio giving you high-quality audio consistently, every time, everywhere.

With user-friendly configuration tools and advanced signal processing capabilities, our PAVA range offers audio customization features such as Automatic Volume Control, Dynamic Range Compression, Time Alignment, and EQ adjustments. These features ensure optimal sound quality tailored to suit specific environments.



Acoustic echo cancellation



Automatic Gain Control



Active Noise Cancellation

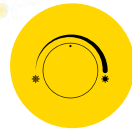

Automatic Volume Control

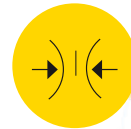

Dynamic Range Compression



As PAVA systems become more integrated and remotely accessible, they also become potential entry points for cyberattacks. That's why cybersecurity isn't an afterthought at Zenitel, it's embedded into the core of our solutions.

Our PAVA systems are designed with a "defence-in-depth" approach, meaning multiple layers of security are implemented to reduce risk, prevent breaches, and ensure system continuity.

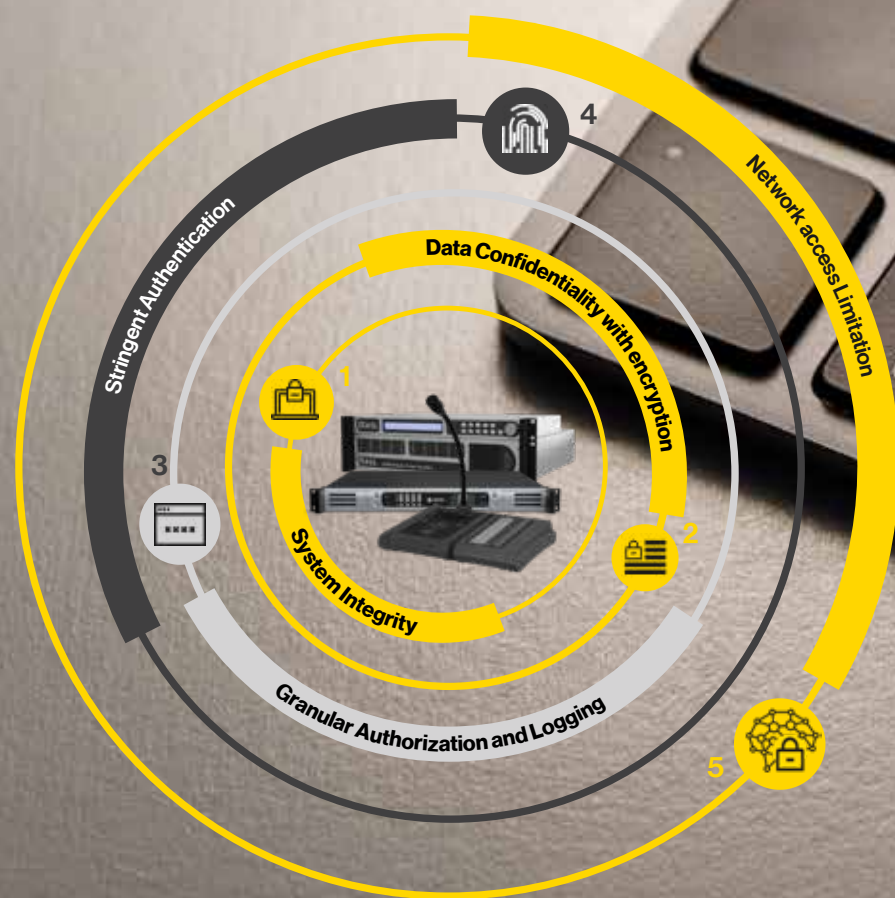

**Designed for Cybersecurity.**  
**Built for Resilience.**

# VIPEDIA

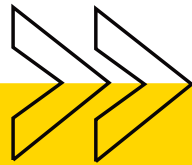

- **Scalable by design**  
Supports up to 32 Vipedia routers over IP networks, enabling seamless expansion from single sites to large, multi-site deployments
- **Engineered for superior audio performance**  
Advanced DSP ensures clear, intelligible announcements and high-quality background audio across all environments.
- **Cybersecurity built-in**  
IEC 62443-4-2 compliant, delivering robust protection for critical communication systems.
- **Designed for continuous operation**  
No single point of failure, with built-in redundancy to ensure system availability when it matters most.
- **Flexible architecture**  
Adapts to evolving operational needs, supporting long-term scalability and system longevity.



Stadiums



Train Stations



Hospitals



Airports



Industry

# INTEGRA

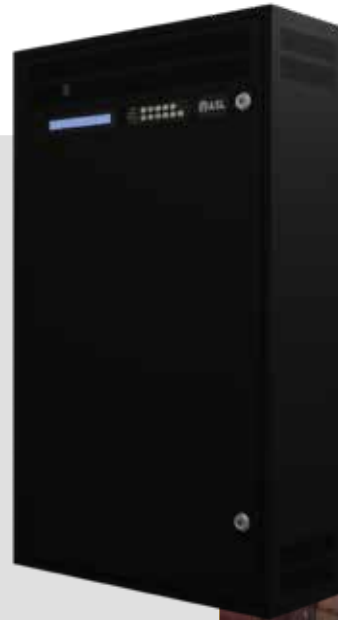

- Self-contained Wall Mount Voice Alarm
- Easy installation & Setup
- Integrated IP Audio Networking
- Pre-installed with 3, 5, 7 or 10 amplifier cards pre-installed
- Up to 2000W total load
- DC/IMPEDANCE loop loudspeaker monitoring



# Zenitel VAIA



- Patented amplifier technology delivering ultra-high density amplification
- Built-in Back up amplifier
- Up to 1000W continuous power output across 4 Class-D amplifier channels
- Intelligent Flexi power distribution for power load distribution

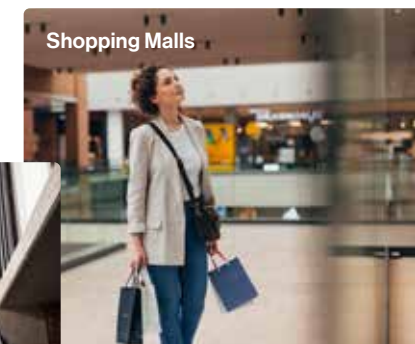

# Unified PAVA Portfolio



Max number of audio routers in a EN54 system

Max of num audio zones in a single EN54 system

Dynamic Volume Adjustment

EQ

Power sharing among amplifier modules

Simultaneous Live Broadcast per router

Simultaneous Pre-recorded messages per router

Integrated Backup amplifier

Battery Charger integrated

DANTE Compatibility

Integrated amplifier

## VIPEDIA + V2000

320

3840

YES

YES

YES

6 SIMULTANEOUS CALLS  
IN AND OUT

8 PLAYERS

OPTIONAL

YES

YES

SEPARATE

## INTEGRA

320

3200

YES

YES

YES

6 SIMULTANEOUS CALLS  
IN AND OUT

8 PLAYERS

OPTIONAL

YES

YES

YES

## Zenitel VAIA

4 (unlimited for PA only)

16

YES

YES

YES

4 SIMULTANEOUS CALLS  
IN AND OUT

4 PLAYERS

YES

YES

NO

YES

# Wide Range of Accessories

Cross-compatible microphones and accessories work across Zenitel's entire PAVA portfolio, allowing you to build and expand your system seamlessly.



**DESKTOP MIC PANELS**



**EMERGENCY MICROPHONES PANELS**



**DYNAMIC NOISE SENSOR**



**VIPA WORKSTATION**



# WE'RE THE VOICE BEHIND

## MANY LANDMARKS

### London Underground

VIPEDIA - EN54 Compliant Solution

### Gatwick Airport

VIPEDIA - EN54 Compliant Solution

### Bane NOR

VIPEDIA - EN54 Compliant Solution

### Paris La Défense Arena

VIPEDIA- EN54 Compliant Solution

### Nagpur Metro

VIPEDIA - EN54 Compliant Solution

### Tunelovy Rozhlas Tunnel

VIPEDIA - EN54 Compliant Solution

### Malta International Airport

INTEGRA - Centralised Control Solution

### Burjee Medical City

VIPEDIA - EN54 Compliant Solution

### Dubai Healthcare City

VIPEDIA - UAE fire coderequirements

### Follo Tunnel Line

VAIA - Emergency Audio system

### Bengaluru Metro

VIPEDIA - EN54 Compliant Solution

**AND MANY MORE**

# Powerfully Simple. Clarity You Can Trust.



Corporate & Public



Education



Healthcare



Hospitality



Industry



Prison



Retail & Logistic



Smart City



Transportation

## About Zenitel

Zenitel is well positioned to drive the future of intelligent critical-communication solutions. Through our portfolio of IP products & solutions, with built-in intelligence and a focus on cybersecurity, we provide organisations with superior, scalable security and flexibility. Zenitel is the proven, preferred choice for environments requiring crystal-clear audio to ensure the protection of human life, property, assets and the management of critical activities. With interoperability at all levels, we seamlessly integrate with access control, video management and security platforms.