



ONSHORE,  
SAFETY & SECURITY

## Unified Critical Communication

- To hear, be heard and be understood, every time and everywhere



# Product Catalog



# Welcome!

## Zenitel Product Catalog 2026

In environments where seconds matter, Zenitel helps organizations ensure **every critical message is heard**, understood, and acted upon. Our solutions are built to enhance safety, security, and operational efficiency - when it matters most.

Zenitel is moving beyond standalone systems toward a **unified critical communication approach**, bringing intercom, IP audio, PAVA and related technologies into a cohesive, scalable platform. With **Zenitel Connect Pro**, we enable clearer integration, interoperability, and a stronger connection between critical communication and the wider security ecosystem.

At the same time, Zenitel is expanding lifecycle support with **cloud-assisted monitoring and remote management**, helping customers and partners maintain performance across sites, reduce downtime, and operate more proactively.

Welcome to the 2026 Zenitel Product Catalog - your overview of unified critical communication solutions designed for clarity, resilience, and long-term value.

# Contents

4	Zenitel Connect Pro - Unified Critical Communication Platform	4
	Zenitel Cloud - Remote Monitoring & Management	6
	PAVA - Public Address and Voice Alarm	8
	Segment Solutions	10
12	Audio Intercom	12
	Video Intercom	16
	Door Intercom	19
	IC-EDGE Video Entry Starter Kits	20
	Intercom Accessories	22
26	Desktop, Control Room, Clean Room Stations	26
	Accessories	29
34	Industrial & EX IP Intercom	34
	Industrial & EX IP Station Accessories	37
	Flowire Converter	39
	Heavy-Duty IP Stations	40
42	PAVA - Products (VIPEDIA, amplifiers, accessories)	42
	SIP Amplifiers	45
	PAVA Accessories	46
	IP Speakers	48
50	Emergency Stanchions and Wall Units	50
	Emergency Stanchions and Wall Units Accessories	54
55	IP Station Kits	55
	Emergency Stanchions and Wall Units Accessories	58
59	Zenitel Connect Pro - Products and Licenses	59
	Cloud Device Monitoring & Management	62
	ICX-510 Accessories	63
64	ICX-AlphaCom	64
	Analog Stations	70
	Licenses	72

# Zenitel Connect Pro

## Unified Critical Communication Platform

Zenitel Connect Pro is the unified critical communication platform for safety and security operations, bringing intercom, IP speakers, public address, voice alarm, and general alarm into one cohesive, software-driven system.

By connecting what operators see with what they hear, Zenitel Connect Pro strengthens situational awareness and speeds up coordinated response across control room workflows and on-site teams. The platform integrates smoothly with video, access control, and third-party security systems - built on open standards such as SIP and ONVIF, and supported by Zenitel Link interfaces (REST API + PubSub) for deeper integration.

Zenitel Connect Pro offers flexible deployment options: install on a dedicated ICX-510 server or in supported x64 virtualized environments. System configuration and daily operations are managed via web, and the platform supports native audio and video communications for modern operator workflows.

When required, Cloud Connection can be enabled to support cloud-assisted monitoring and remote management, helping partners and customers maintain system health across sites more efficiently.

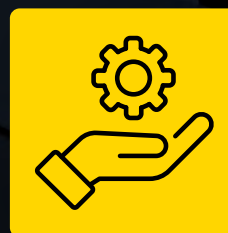
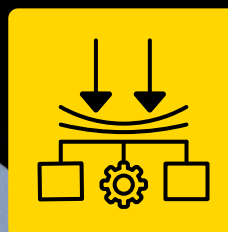
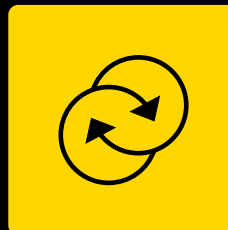

### Seamless Integration

Open standards (SIP, ONVIF) and Zenitel Link APIs (REST + PubSub) simplify integration with VMS, access control, and security platforms—reducing project risk and accelerating time to value. For tailored site logic, native Node-RED support enables customized automation workflows tightly integrated with security platforms.

### Resilient Communication

Unifying multiple communication technologies reduces reliance on a single channel and strengthens resilience across daily operations and emergencies. A single platform helps maintain consistent procedures and clear communications across sites - also when parts of the wider ecosystem are degraded.

### Faster Response

Unified workflows link audio, video, and events—supporting faster incident verification, clearer coordination, and more confident decision-making in the moment. Integrated communications reduce handoffs between tools and help operators act on real-time operational signals.

### Simplified Operation

One interface reduces operator training time and standardises operations across sites. Web-based administration, scalable software-driven architecture, and service-ready workflows support predictable lifecycle management - reducing on-site interventions and improving operational readiness over time.

# Zenitel Cloud

## Remote Monitoring & Management

**Zenitel Cloud Remote Monitoring & Management (ZC-RMM) is the cloud companion to Zenitel Connect Pro, unifying visibility and operational control of Zenitel devices across customers and sites. Partners anchor deployments with Zenitel Connect Pro, enabling quick onboarding via Device Cloud ID and automatic organization of connected endpoints.**

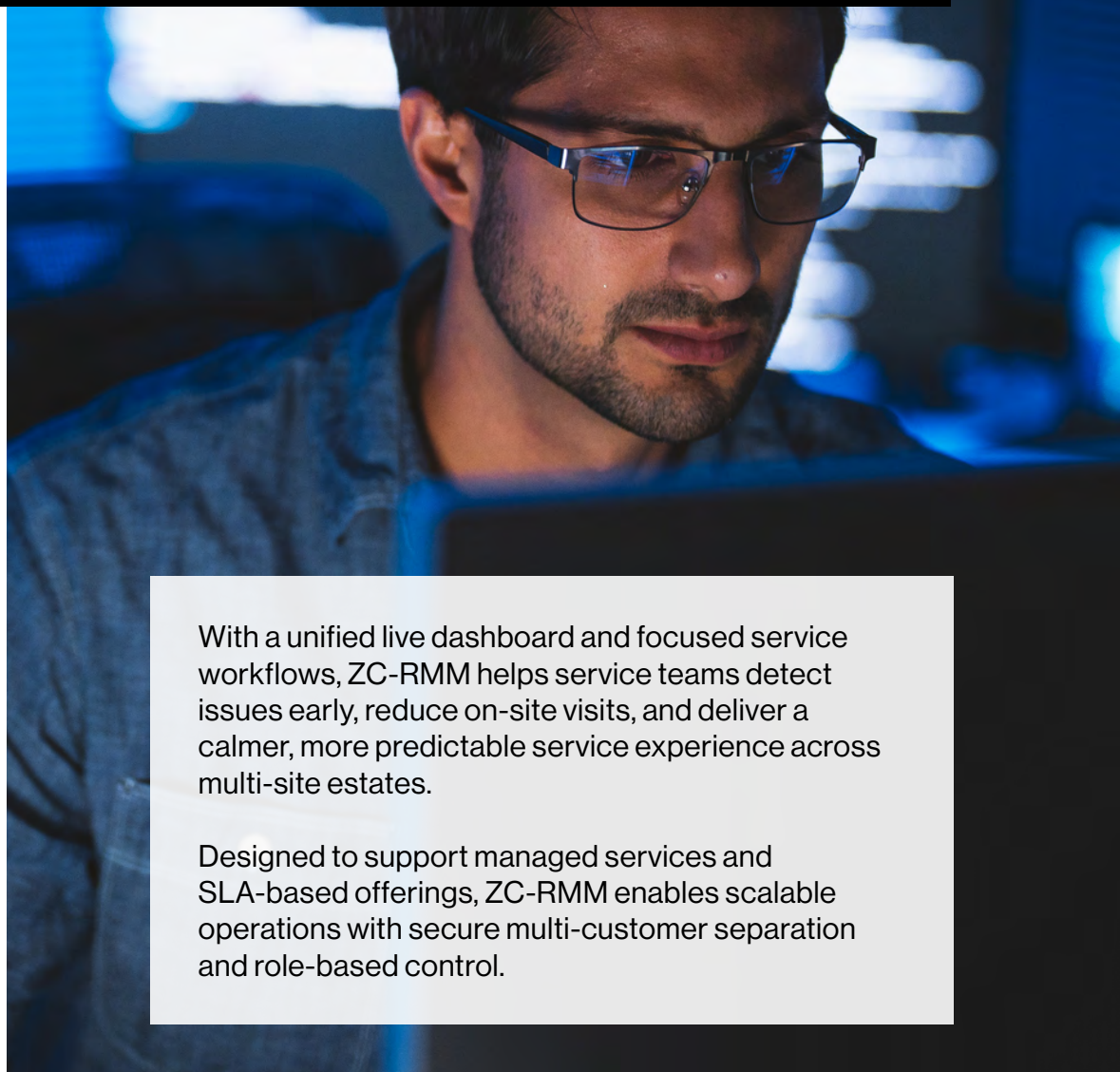

With a unified live dashboard and focused service workflows, ZC-RMM helps service teams detect issues early, reduce on-site visits, and deliver a calmer, more predictable service experience across multi-site estates.

Designed to support managed services and SLA-based offerings, ZC-RMM enables scalable operations with secure multi-customer separation and role-based control.



### Secure

Security by design with least-privilege access and encrypted communications. Customer and Space scoping plus role-based permissions keep data and actions contained. Zenitel Cloud RMM is positioned with alignment to ISO 27001 and compliance statements for GDPR and SOC 2.

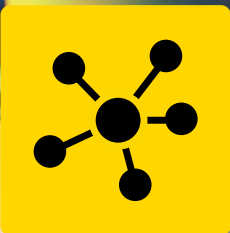

### Centralized

One cloud interface provides unified visibility across customer projects and sites, with at-a-glance health and trends for the full estate.

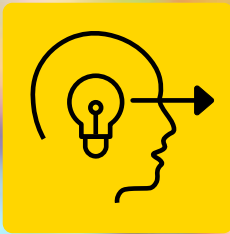

### Proactive

Continuous monitoring helps detect anomalies early and accelerate fault isolation, moving from reactive checks to proactive maintenance.



### Operational

Practical workflows for real service work: guided claiming/onboarding, maintenance windows, bulk actions, and lifecycle tools that reduce downtime and truck rolls.

# PAVA

## Public Address and Voice Alarm

Zenitel's Public Address and Voice Alarm\* solutions deliver clear, reliable audio for public address, voice evacuation and life-safety messaging. The same platform can also support operational announcements and background music, helping organizations manage both daily communication and critical events.

In an emergency, voice-assisted evacuation enables location-specific messaging and phased guidance, helping reduce confusion and accelerate response compared to traditional alarm tones. Beyond fire scenarios, PAVA also supports mass notification and security announcements for situations such as lockdowns, industrial incidents, and other threats.

Designed as part of Zenitel's Unified Critical Communication offering, PAVA helps keep people informed, protect facilities and maintain calmer, more predictable operations across regulated and safety-critical environments.

*\*Vipedia and Integra products are pending UL certification for the US market.*



### Clear intelligibility

High speech intelligibility for emergency and operational messages, with consistent coverage in challenging acoustic environments.

**EN 54-16**

### Life-safety ready

Designed for regulated life-safety environments with EN 54\*-aligned architectures, with EN 54-16 referenced across the portfolio. Additional certifications may apply depending on solution and market.  
*\*Pending UL certification for the US market.*



### Resilient operation

End-to-end monitoring and comprehensive fault reporting across the audio chain support dependable operations when it matters most.

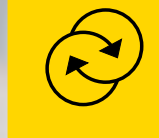

### Integrated workflows

Designed to interface with life-safety and security ecosystems such as fire alarm interfaces, as well as CCTV/VMS and access control workflows.

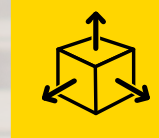

### Scalable architecture

Modular architectures scale from smaller facilities to large, complex estates, with options for centralized or decentralized design and multiple levels of redundancy for higher serviceability.

**Explore the PAVA portfolio**  
See VIPEDIA, amplifiers, and accessories in the product section.

# Segment Solutions

## Critical communication tailored to each segment

Zenitel supports segment-specific communication needs through one unified platform approach. Across corporate and public, transportation, industrial, healthcare, correctional and education environments, Zenitel combines intercom, IP audio, public address, and lifecycle support to enable a safer and more consistent response.

**Corporate and Public** - Critical communication across entrances, buildings, and campuses.

**Transportation** - Help points, staff communication, and operational announcements for stations, terminals, and infrastructure.

**Industrial** - Rugged communication for high-noise, harsh, and safety-critical environments.

**Healthcare** - Secure communication for critical areas, controlled access points, and staff coordination.

**Prisons and Corrections** - Robust communication for high-security operations, including emergency call points and controlled announcements.

**Education** - Unified campus communication for entrances, shared areas, and emergency messaging.

## One unified platform across all segments

Zenitel's unified approach connects segment-specific needs to one scalable platform model, combining intercom, IP audio, PAVA, and cloud-assisted lifecycle support.

**Zenitel Connect Pro** - Unifies operator workflows by bringing intercom, IP audio and integrations into one operational experience across sites and systems.

**PAVA** - Adds trusted public address and voice alarm capabilities for regulated areas and life-safety applications where these functions are required.

**ZC-RMM** - Provides central visibility, proactive monitoring, diagnostics and lifecycle support to help maintain performance across distributed and multi-site deployments.



### Interoperability

Zenitel Connect Pro enables unified workflows across systems by integrating critical communication with wider security ecosystems.

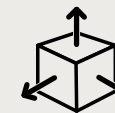

### Scalability

Solutions scale from single sites to multi-site estates, supported by flexible deployment models and modular expansion.



### Reliability

Supervision, fault reporting, and resilient architectures support dependable operation for everyday use and critical events.



### Ease of Use

Designed with intuitive interfaces, ensuring that personnel can act faster and more consistently under pressure.

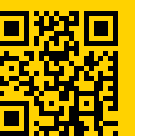

# Audio Intercom

## Zenitel's IP & SIP Intercom

### Key Features

- **Superior audio performance** - powered by advanced audio features such as high Sound Pressure Levels (SPL) Automatic Volume Control, Active Noise Cancelling, Voice Activity Detection, and Acoustic Echo Cancellation to ensure crystal-clear audio in any environment.
- **Weather-Resistant** - IP-rated for resistance to dust, dirt, and water.
- **Rugged construction** - High-impact protection rating for rugged environments.
- **Advanced Supervision** - Continuous monitoring with line and tone tests for system integrity.
- **Cybersecurity Hardened** - Meets industry security standards to protect against cyber threats.
- **IP-Based Connectivity** - Supports a wide set of IP and networking standards for seamless integration.
- **Power over Ethernet (PoE)** - Simplifies installation and reduces cabling requirements.

ZENITEL CONNECT PRO ICX-AlphaCom IC-EDGE SIP Onvif

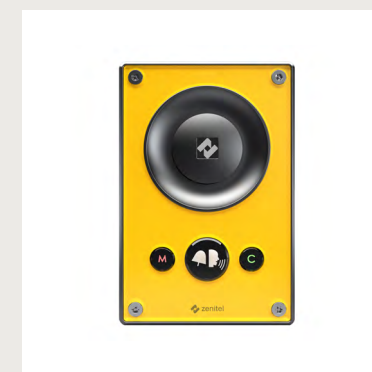

TCIS-1  
1008111010  
IP and SIP Intercom

- LED lit call button, and two PTT buttons M (manual speech) and C (cancel)

IP66 IK08

**Dimensions:**

- Size (HxWxD): 7.1" x 4.7" x 0.9"
- Weight: 1.8 lbs

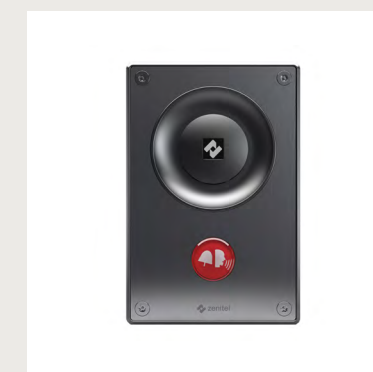

TCIS-2  
1008111020  
IP and SIP Intercom

- LED lit call button
- 3mm stainless steel faceplate

IP66 IK10

**Dimensions:**

- Size (HxWxD): 7.1" x 4.7" x 0.9"
- Weight: 1.8 lbs

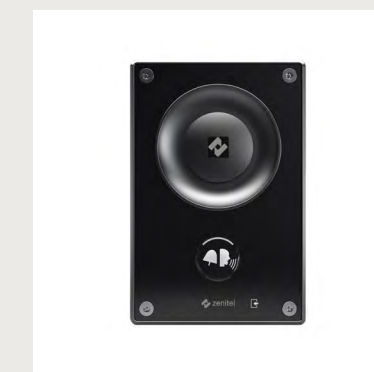

TCIS-3  
1008111030  
IP and SIP Intercom

- LED lit call button
- Door open LED indicator

IP66 IK08

**Dimensions:**

- Size (HxWxD): 7.1" x 4.7" x 0.9"
- Weight: 1.8 lbs

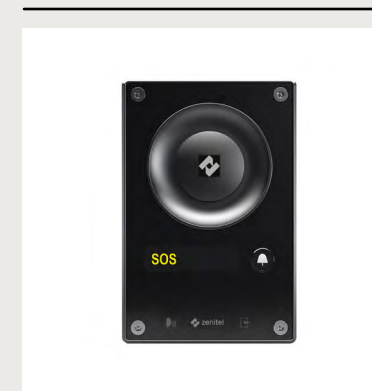

TCIS-4  
1008111040  
IP and SIP Intercom

- LED lit and labelled call button
- Call and door open LED indicators
- PMOLED display

IP66 IK08

**Dimensions:**

- Size (HxWxD): 7.1" x 4.7" x 0.9"
- Weight: 1.8 lbs

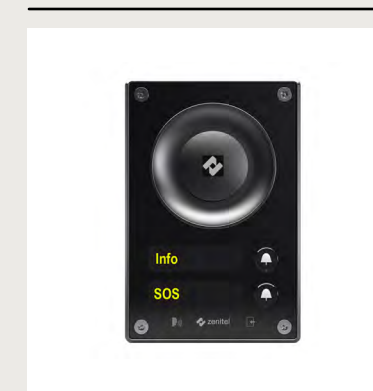

TCIS-5  
1008111050  
IP and SIP Intercom

- Two LED lit and labelled call buttons
- Call and door open LED indicators
- Two PMOLED displays
- Storage for two addresses for outgoing calls

IP66 IK08

**Dimensions:**

- Size (HxWxD): 7.1" x 4.7" x 0.9"
- Weight: 1.8 lbs

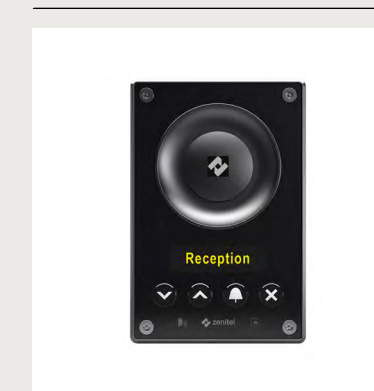

TCIS-6  
1008111060  
IP and SIP Intercom

- Four LED lit buttons for scrolling, call and cancel
- Call and door open LED indicators
- PMOLED display
- Storage for up to 50 addresses

IP66 IK08

**Dimensions:**

- Size (HxWxD): 7.1" x 4.7" x 0.9"
- Weight: 1.8 lbs

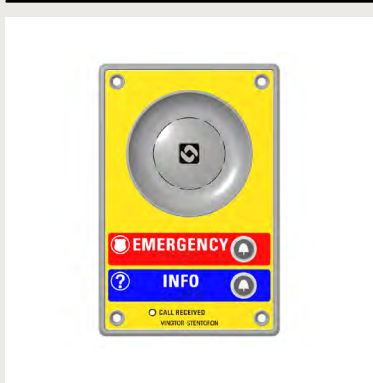

**TCIS-C1**  
**100811901**  
IP and SIP Intercom

- Two LED lit and labelled call-buttons and Braille
- Provides storage for two addresses for outgoing calls

**IP66 IK08**

**Dimensions:**

- Size (HxWxD): 7.1" x 4.7" x 0.9"
- Weight: 1.8 lbs

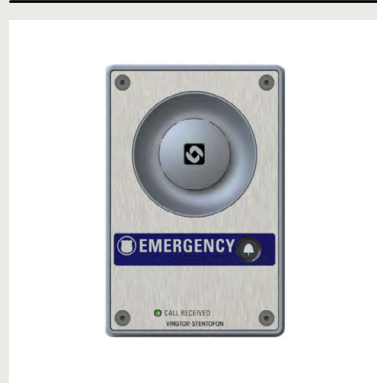

**TCIS-4C8**  
**100811908**  
IP and SIP Intercom

- One LED lit Emergency call button with Braille, and LED indicator for call status.
- 3mm stainless steel faceplate

**IP66 IK10**

**Dimensions:**

- Size (HxWxD): 7.1" x 4.7" x 0.9"
- Weight: 1.8 lbs



**TMIS-1**  
**1008116010**  
IP and SIP Mini Intercom

- LED lit call button
- Call and door open LED indicators

**IP42**

**Dimensions:**

- Size (HxWxD): 117 x 117 x 39mm
- Weight: 0.3kg

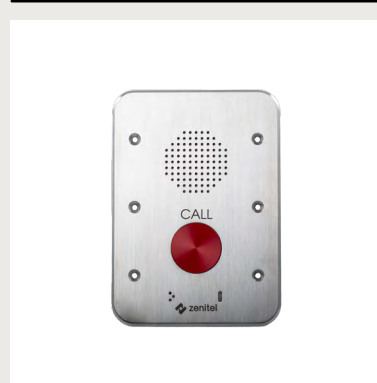

**VR3G-1P**  
**1008021015**  
Vandal Resistant, 3 gang, 1 Piezo button IP and SIP Intercom

- Piezo Call Button with Self-test capability
- LED lit call indicator
- 3mm stainless steel faceplate
- Tamper switch

**IP66 IK10**

**Dimensions:**

- Size (HxWxD): 6.2" x 4.4" x 2.3"
- Weight: 1.6 lbs

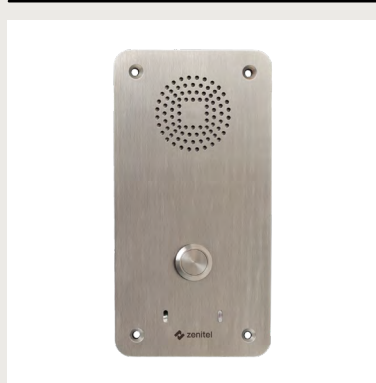

**IPVRS-1**  
**1008041200**  
Vandal Resistant IP and SIP Intercom

- One call button
- LED lit call indicator
- 2mm stainless steel faceplate
- 2 Relay outputs

**IP55 IK08**

**Dimensions:**

- Size (HxWxD): 7.1" x 3.6 x 1.8"
- Weight: 1.8 lbs

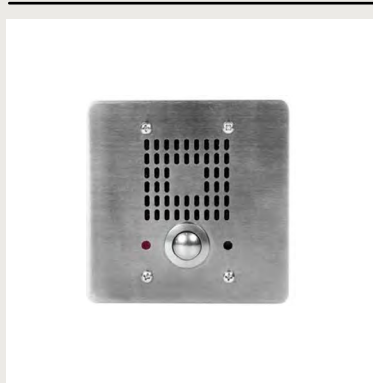

**TMIS-2NL**  
**1008116020NL**  
Turbine Mini Intercom

- One call button
- Call and door open LED indicators
- Stainless steel front plate

**Dimensions:**

- Size (HxWxD): 4.6" x 4.6" x 1.6"
- Weight: 0.7 lbs

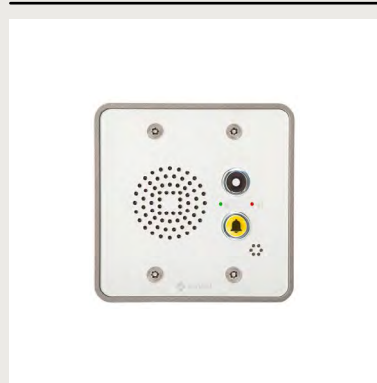

**TMIS-4**  
**1008116040**  
IP and SIP Mini Intercom - 2 Buttons

- LED lit call and PTT buttons
- Call and door open LED indicators

**IP42**

**Dimensions:**

- Size (HxWxD): 4.6" x 4.6" x 1.6"
- Weight: 0.7 lbs



**VR3G-1**  
**1008021010**  
Vandal Resistant, 3 gang, 1 button IP and SIP Intercom

- One call button
- LED lit call indicator
- 3mm stainless steel faceplate
- Tamper switch

**IP66 IK10**

**Dimensions:**

- Size (HxWxD): 6.2" x 4.4" x 2.3"
- Weight: 1.6 lbs

# Video Intercom



## Zenitel's IP and SIP Video Intercom

### Key features

- **HD Video Resolution** - Delivers clear, sharp video for better identification and communication.
- **Wide-Angle Camera** - Provides a broad view of the surroundings for enhanced security and visibility.
- **Superior Audio Performance** - High Sound Pressure Levels (SPL), Active Noise Cancelling, Automatic Volume Control, and Acoustic Echo Cancellation ensure crystal-clear audio in any environment.
- **Weather-Resistant** - IP-rated for resistance to dust, dirt, and water.
- **Rugged construction** - High impact protection rating for rugged environments
- **Cybersecurity Hardened** - Meets industry security standards to protect against cyber threats.
- **IP-Based Connectivity** - Supports a wide set of IP and networking standards for seamless integration.

ZENITEL CONNECT PRO ICX-AlphaCom IC-EDGE SIP ONVIF

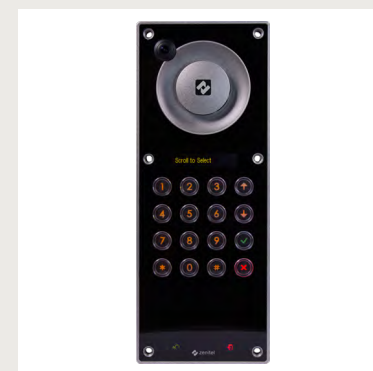

TEIV-1+  
1008317110

Turbine Extended IP Video Intercom with Keypad and Display

- Full numeric LED lit keypad with scroll, confirm and cancel keys
- Call and door open LED indicators
- Can operate door controller via I/O relay

IP66 IK08

**Dimensions:**

- Size (HxWxD): 12" x 4.7" x 2.9"
- Weight: 2.38 lbs

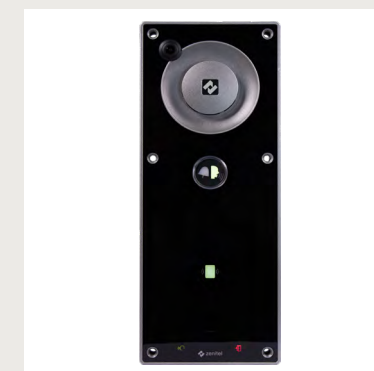

TEIV-4+  
1008318240

Turbine Extended IP Video with RFID card reader space

- Easy installation of access control end-points
- Call and door open LED indicators
- Includes space for 3rd party Card Readers

IP66 IK08

**Dimensions:**

- Size (HxWxD): 12" x 4.7" x 2.9"
- Weight: 2.31 lbs

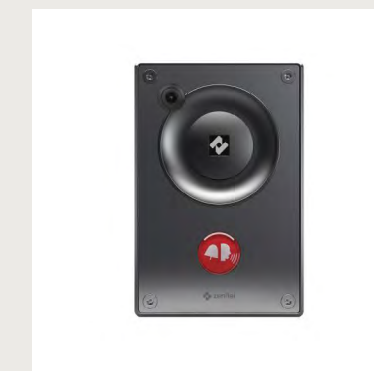

TCIV-2+  
1008315020

IP and SIP Video Intercom

- One call button
- 3mm stainless steel faceplate

IP66 IK10

**Dimensions:**

- Size (HxWxD): 7.1" x 4.7" x 2.2"
- Weight: 2.2 lbs



**TCIV-3+**  
**1008315030**  
IP and SIP Video Intercom

- One call button
- Door open LED indicator

IP66 IK08

**Dimensions:**

- Size (HxWxD): 7.1" x 4.7" x 2.2"
- Weight: 2.2 lbs



**TCIV-5+**  
**1008315050**  
IP and SIP Video Intercom

- Two call buttons
- Call and door open LED indicators
- Two PMOLED displays
- Provides storage for two addresses for outgoing calls

IP66 IK08

**Dimensions:**

- Size (HxWxD): 7.1" x 4.7" x 2.2"
- Weight: 2.2 lbs



**TCIV-6+**  
**1008315060**  
IP and SIP Video Intercom

- Four buttons for scrolling, call and cancel
- Call and door open LED indicators
- One PMOLED display
- Provides storage for up to 50 addresses for outgoing calls

IP66 IK08

**Dimensions:**

- Size (HxWxD): 7.1" x 4.7" x 2.2"
- Weight: 2.2 lbs



**TMIV-1+**  
**1008117010**  
IP and SIP Mini Video Intercom

- One call button
- Call and door open LED indicators

IP44

**Dimensions:**

- Size (HxWxD): 117 x 117 x 39mm
- Weight: 0.3kg

## Zenitel's New Door Intercoms

Two IP video door intercoms for modern access control - designed for confident visitor verification, clear conversations in real-world noise, and straightforward integration into building systems.

**ZDD-1** - A premium door station for multi-tenant and corporate entrances, combining a bright 7" touch display with powerful audio and wide-angle HD video for an intuitive visitor experience.

**ZSD-1** - A compact, mullion-mounted door station for narrow frames - delivering strong audio performance and wide FoV video in a slim footprint.

Both stations combine wide-angle HD video with Digital PTZ for quick visitor verification, while HD voice with Open Duplex and advanced noise/echo control deliver clear, natural conversations. Designed for secure, standards-based deployments, the stations support HTTPS, SRTP and 802.1X, and integrate smoothly via SIP/SIPS, ONVIF, and RTSP. Built for harsh environments, they combine IP66 / IK08 protection with a -13°F to +131°F operating range. PoE power options simplify installation by reducing cabling and accelerating rollout.



**ZDD-1**  
**1008510101**  
IP Video Intercom with Display

- 7" TFT LCD display
- Touch screen with intuitive menu and user-friendly interface
- Slim, space-saving design for modern entrances

IP66 IK08

**Dimensions:**

- Size (HxWxD): 11.1" x 6.9" x 1.7"
- Weight: 3.75 lbs



**ZSD-1**  
**1008325010**  
Slim IP Video Intercom

- Designed for mullion mounting
- LED-lit call button
- Slim design for tight spaces and door-frame installations

IP66 IK08

**Dimensions:**

- Size (HxWxD): 7.75" x 1.9" x 1.2"
- Weight: 0.4 lbs

# IC-EDGE Video Entry Starter Kits

The IC-EDGE Video Entry Starter Kit is a complete, easy-to-install solution for secure and reliable video entry communication. Designed to deliver clear, intelligible audio and high-resolution video, it enables confident visitor identification in both quiet and noisy environments.

With advanced noise-cancelling technology, PoE installation, web-based management and support for up to 64 stations, the system is ideal for scalable access communication. Its rugged, weather-resistant design makes it suitable for both indoor and outdoor use, while configurable call, relay and access control settings provide flexibility for a wide range of installations.



new



**ZSD1KIT**  
**5552604710**  
IP and SIP Video Intercom

- LED-lit call button
- IP Phone with 7" Screen

**IP66 IK08**

**Kit:**

- 1000712 IP Touch Station ITS-1
- 1008325010 IP and SIP Video Intercom ZSD-1

new



**ZSD4KIT**  
**555260113410**  
IP and SIP Video Intercom

- LED-lit call button
- HD IP Video Phone with 5" Screen

**IP66 IK08**

**Kit:**

- 1490004010 IP Touch Station with Video ITSV-4
- 1008325010 IP and SIP Video Intercom ZSD-1

new



**ZSD5KIT**  
**555260113510**  
IP and SIP Video Intercom

- LED-lit call button
- HD IP Video Phone with 8" Screen

**IP66 IK08**

**Kit:**

- 1490005010 IP Touch Station with Video ITSV-5
- 1008325010 IP and SIP Video Intercom ZSD-1

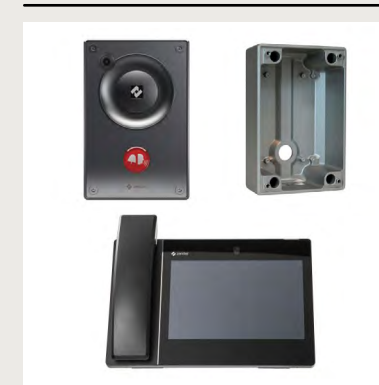

**TV52+**  
**5552301530**  
IP and SIP Video Intercom

- One call button
- 3mm stainless steel faceplate
- HD IP Video Phone with 8" Touch Screen

**IP66 IK10**

- Kit:**
- 1008315020 TCIV-2+ IP and SIP Video Intercom
  - 1490005010 ITSV-5 IP Touch Station with Video
  - 1008140010 TA-1 Turbine Compact On Wall Box

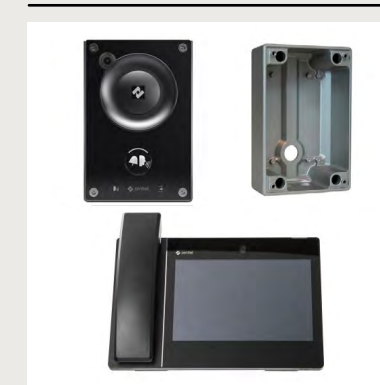

**TV53+**  
**5552301530**  
IP and SIP Video Intercom

- One call button
- Call and door open LED indicators
- HD IP Video Phone with 8" Touch Screen

**IP66 IK08**

- Kit:**
- 1008315030 TCIV-3+ IP and SIP Video Intercom
  - 1490005010 ITSV-5 IP Touch Station with Video
  - 1008140010 TA-1 Turbine Compact On Wall Box

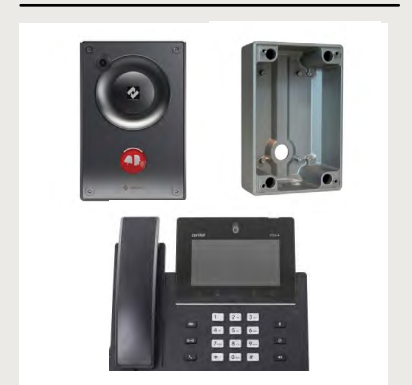

**TV42+**  
**5552301420**  
IP and SIP Video Intercom

- One call button
- 3mm stainless steel faceplate
- HD IP Video Phone with 5" Screen

**IP66 IK10**

- Kit:**
- 1008315020 TCIV-2+ IP and SIP Video Intercom
  - 1490004010 ITSV-4 IP Touch Station with Video
  - 1008140010 TA-1 Turbine Compact On Wall Box

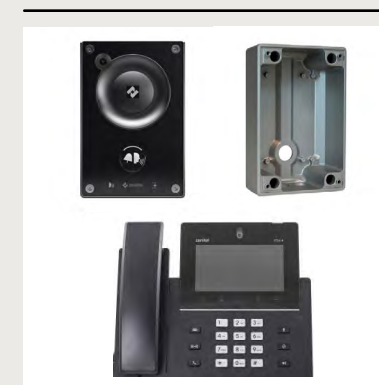

**TV43+**  
**5552301430**  
IP and SIP Video Intercom

- One call button
- Call and door open LED indicators
- HD IP Video Phone with 5" Screen

**IP66 IK08**

- Kit:**
- 1008315020 TCIV-2+ IP and SIP Video Intercom
  - 1490004010 ITSV-4 IP Touch Station with Video
  - 1008140010 TA-1 Turbine Compact On Wall Box

# Intercom Accessories

## On Wall Back Boxes

**new**



**TA-35**  
**1008140350**  
Onwall Backbox

---

**Used with:**

- ZDD-1

---

**Dimensions:**

- Size (HxWxD): 11.05" x 6.9" x 1.05"
- Weight: 0.45 lbs



**TA-1**  
**1008140010**  
Turbine Compact On-wall Back Box

---

**Used with:**

- TCIS Series
- TCIV+ Series

---

**Dimensions:**

- Size (HxWxD): 7.1" x 4.7" x 2.6"
- Weight: 1.7 lbs



**TA-13**  
**1008140130**  
Turbine Mini On-Wall Back Box White

---

**Used with:**

- TMIS Series
- TMIV-1+

---

**Dimensions:**

- Size (HxWxD): 4.8" x 4.9" x 2.55"
- Weight: 0.9 lbs



**TA-32**  
**1008140320**  
Turbine Mini On-Wall Back Box

---

**Used with:**

- TMIS+ Series
- TMIV-1+

**Dimensions:**

- Size (HxWxD): 4.6" x 4.6" x 1.8"
- Weight: 0.9 lbs



**TA-33**  
**1008140330**  
Turbine Extended On-wall Backbox

---

**Used with:**

- TEIV+ Series

**Dimensions:**

- Size (HxWxD): 12" x 4.7" x 2.4"
- Weight: 2.3 lbs



**On Wall Back Box**  
**1008098000**  
On Wall Back Box for IPVRS-1

---

**Used with:**

- IPVRS-1

**Dimensions:**

- Size (HxWxD): 7.1" x 3.6" x 2.05"
- Weight: 1.75 lbs

## Flushmount Back Boxes



**TA-2**  
**1008140020**  
US 2-Gang 3 1/2" Deep Back Box

---

**Used with:**

- TCIS Series
- TCIV+ Series
- TMIS-1
- TMIV-1+

---

**Dimensions:**

- Size (HxWxD): 3.3" x 3.8" x 3.5"
- Weight: 1.1 lbs



**TA-3**  
**1008140030**  
2 1/2" Deep Flushmount Backbox for Turbine Compact Mini

---

**Used with:**

- TMIS-1
- TMIV-1+

---

**Dimensions:**

- Size (HxWxD): 3.3" x 3.8" x 3.5"
- Weight: 1.1 lbs



**1600 TA-18USA**  
**1072814000**  
TA-18USA Flushmount Backbox

---

**Used with:**

- TCIS Series
- TCIV+ Series

---

**Dimensions:**

- Size (HxWxD): 9.1" x 5.95" x 4"
- Weight: 3.3 lbs



**TA-34**  
**1008140340**  
Turbine Extended Flushmount Backbox

**Used with:**

- TEIV+ Series

**Dimensions:**

- Size (HxWxD): 12.1" x 4.7" x 2.36"
- Weight: 2.15 lbs



**Flush Mount Back Box**  
**1008098100**  
Flush Mount Back Box for IPVRS-1

**Used with:**

- IPVRS-1

**Dimensions:**

- Size (HxWxD): 6.6" x 3.15" x 2"
- Weight: 1.75 lbs



**TA-37**  
**1008098300**  
Flush Mount Back Box for IP Vandal Resistant Substation

**Used with:**

- VR3G Series

**Dimensions:**

- Size (HxWxD): 5.7" x 3.85" x 2.6"
- Weight: 1.75 lbs

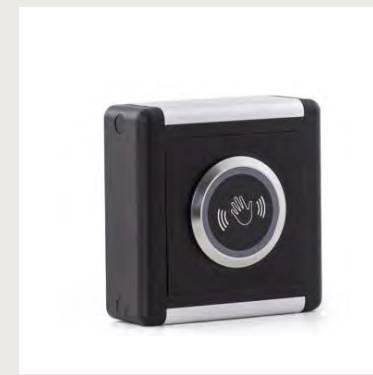

**Touchless Sensor**  
**2390020100**  
Touchless sensor for Turbine Compact stations with Backbox

**Used with:**

- TCIS Series
- TCIV+ Series

**Dimensions:**

- Size (HxWxD): 4.15" x 4.15" x 1.1"
- Weight: 0.45 lbs



**Touchless Sensor Flush Mount**  
**2390020101**  
Touchless sensor for Turbine Compact stations

**Used with:**

- TCIS Series
- TCIV+ Series

**Dimensions:**

- Size (HxWxD): 4.15" x 4.15" x 1.1"
- Weight: 0.45 lbs

## Miscellaneous



**TA-5**  
**1008140050**  
Bracket for US 2 GANG Double Depth Back Box

**Used with:**

- TCIS Series
- TCIV+ Series

**Dimensions:**

- Size (HxWxD): 6.65" x 4.3" x 0.4"
- Weight: 0.45 lbs

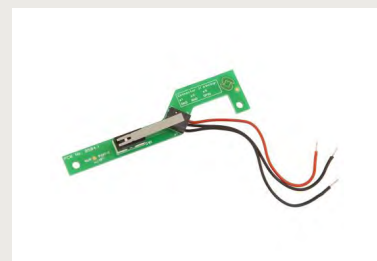

**Tamper Switch**  
**1008091010**  
Tamper Switch for Vandal Resistant Substation TKIE

**Used with:**

- IPVRS-1



**TA-14**  
**1008140140**  
Microphone windshield for TCIS / TCIV+

**Used with:**

- TCIS Series
- TCIV+ Series

**Dimensions:**

- Size (HxWxD): 0.6" x 14.3" x 0.5"

# Desktop, Control Room and Clean Room Stations

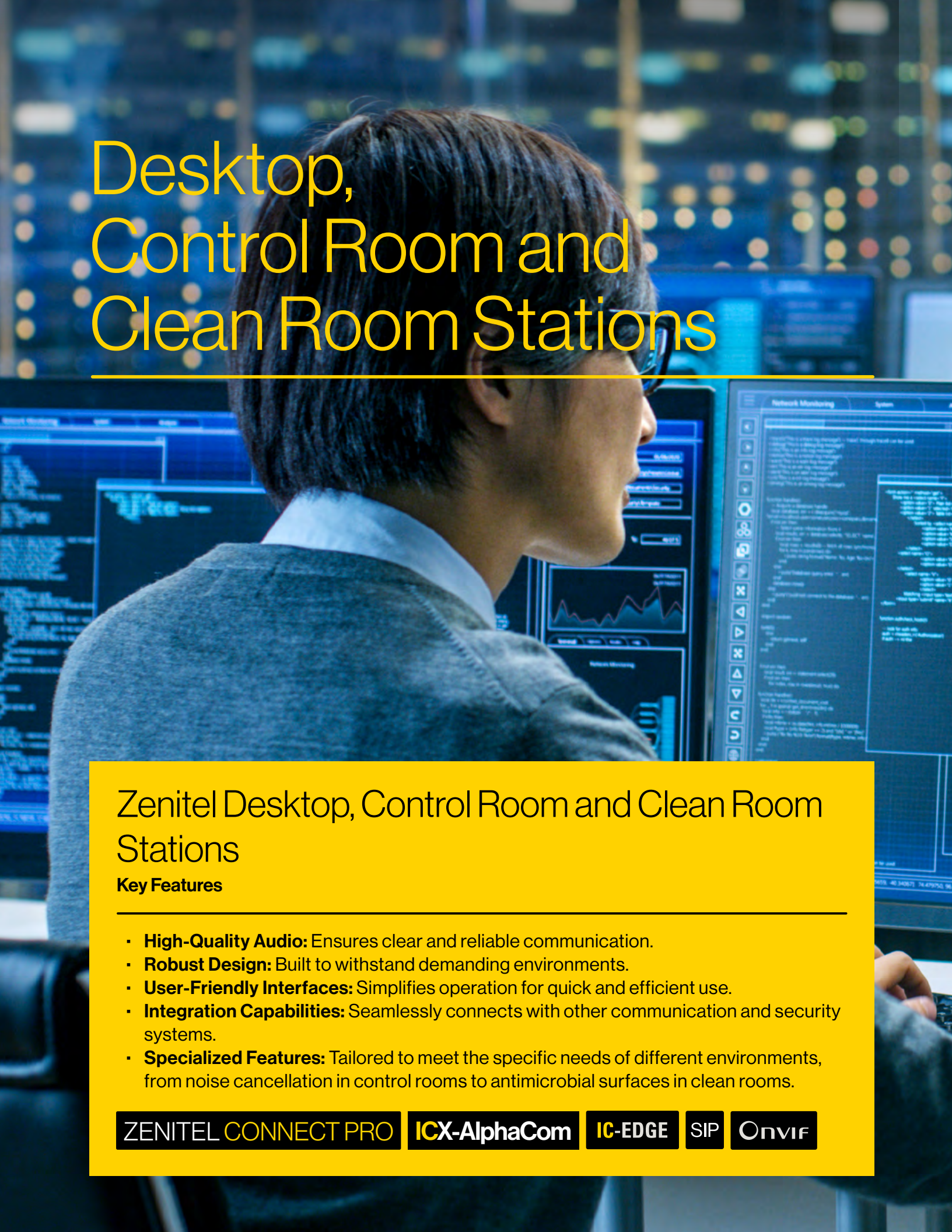

## Zenitel Desktop, Control Room and Clean Room Stations

### Key Features

- **High-Quality Audio:** Ensures clear and reliable communication.
- **Robust Design:** Built to withstand demanding environments.
- **User-Friendly Interfaces:** Simplifies operation for quick and efficient use.
- **Integration Capabilities:** Seamlessly connects with other communication and security systems.
- **Specialized Features:** Tailored to meet the specific needs of different environments, from noise cancellation in control rooms to antimicrobial surfaces in clean rooms.

ZENITEL CONNECT PRO ICX-AlphaCom IC-EDGE SIP ONVIF

new

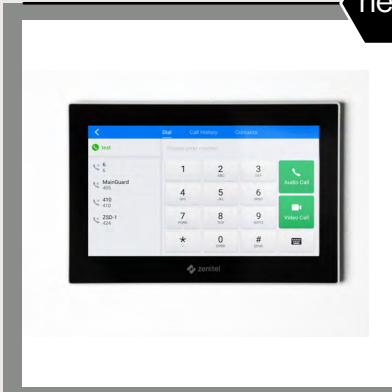

**ITS-1**  
**1000712**  
IP Phone with 7" Screen

- 6 lines with up to 6 SIP accounts
- 7" (1024x600) capacitive 10-point touch screen TFT LCD
- H.264 BP/MP/HP and M-JPEG streaming, video resolution up to 720p, frame rate up to 30 fps, bit rate up to 2Mbps
- Full duplex 2-way HD audio with advanced echo cancellation

**Dimensions:**  
• Size (HxWxD): 1" x 7.16" x 4.8"  
• Weight: 0.9 lbs

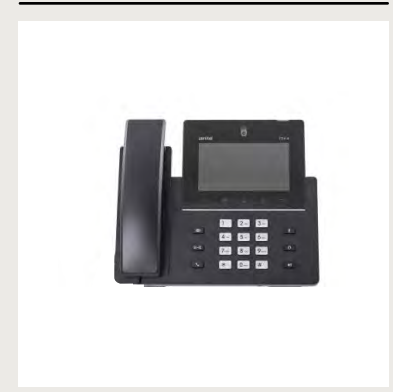

**ITSV-4**  
**1490004010**  
HD IP Video Phone with 5" Screen

- 16 lines with up to 16 SIP accounts
- 5.0" (1280x720) capacitive 5-point touch screen HD TFT LCD
- Built-in 2 mega-pixel CMOS tiltable camera with privacy shutter, 720p 30fps
- 10-way audio conferencing and 3-way video conferencing capability

**Dimensions:**  
• Size (HxWxD): 1.9" x 9.55" x 8.25"  
• Weight: 2.2 lbs



**ITSV-5**  
**1490005010**  
HD IP Video Phone with 8" Screen

- 16 lines with up to 16 SIP accounts
- 8" (1280x800) capacitive 10-point touch screen HD IPS LCD
- Built-in 2 mega-pixel CMOS tiltable camera with privacy shutter
- 12-way audio conferencing and 3-way 1080p 30fps video conferencing capability

**Dimensions:**  
• Size (HxWxD): 1.9" x 10.35" x 6.85"  
• Weight: 2.4 lbs



**IPDM-V2**  
**1008400000**  
IP Desk Master V2

- Large, high-contrast display with backlight for excellent readability
- 4 dynamic navigation keys for quick access to system menus and directory entries.
- 10 DAK keys

**Dimensions:**  
• Size (HxWxD): 6.6" x 3" x 6.9"  
• Weight: 1.1 lbs



**IPDMH-V2**  
**1008401000**  
IP Desk Master with Handset V2

- Large, high-contrast display with backlight for excellent readability
- 4 dynamic navigation keys for quick access to system menus and directory entries.
- 10 DAK keys

**Dimensions:**  
• Size (HxWxD): 8.9" x 3" x 6.9"  
• Weight: 1.1 lbs

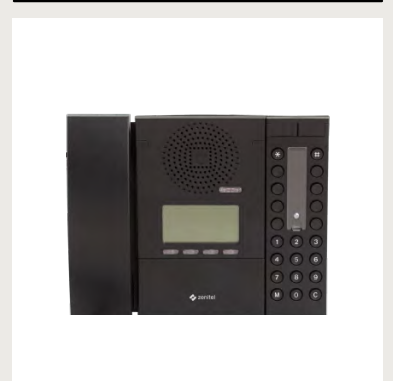

**IPDMHB-V2**  
**1008401100**  
IP Desk Master with Handset (black) V2

- Large, high-contrast display with backlight for excellent readability
- 4 dynamic navigation keys for quick access to system menus and directory entries.
- 10 DAK keys

**Dimensions:**  
• Size (HxWxD): 8.9" x 3" x 6.9"  
• Weight: 1.1 lbs



**CRM-V-2**  
**1008431000**  
IP Flush Master Station

- Aluminium front plate
- 4 dynamic navigation keys and 4 DAK keys for quick access to system menus and directory entries.
- White light behind all keys for excellent readability in dark environments

**Dimensions:**

- Size (HxWxD): 11" x 4.96" x 1.18"
- Weight: 1.14 lbs



**IP-CROR**  
**1008415000**  
IP Intercom Station for Clean Rooms and Hospital Operating Rooms

- Chemical resistant and anti-bacterial front surface for easy cleaning
- Aluminium front plate
- 4 dynamic navigation keys and 4 DAK keys for quick access to system menus and directory entries.
- Designed to meet the requirements of ISO 14644-1, ISO Designation 5

**Dimensions:**

- Size (HxWxD): 11" x 4.96" x 1.18"
- Weight: 1.14 lbs

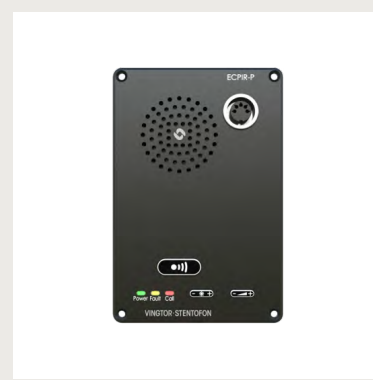

**ECPIR-P**  
**1023200030**  
Exigo Call Panel, PTT Button

- Indicators for power, call, and fault
- Separate PTT button
- LED Indicators for power, call, and fault
- For single or dual systems (A-B systems)
- Supports up to four **EMBDR-8** expansion modules

**Dimensions:**

- Size (HxWxD): 5.7" x 3.8" x 2"
- Weight: 1.1 lbs



**ECPIR-3P**  
**1023200033**  
Exigo Call Panel, Intercom

- Three programmable buttons with individual labels and status indicators
- Indicators for power, call, and fault
- Separate PTT button
- LED Indicators for power, call, and fault
- For single or dual systems (A-B systems)
- Supports up to four **EMBDR-8** expansion modules

**Dimensions:**

- Size (HxWxD): 5.7" x 3.8" x 2"
- Weight: 1.1 lbs

# Desktop, Control Room, and Clean Room Stations Accessories

## Expansion Modules



**CRM-V-DAK48**  
**1008010100**  
48-Key DAK Expansion Module for CRM-V-2

- 48 programmable DAK keys
- Visual indications with two LEDs (green/red) per DAK key
- All keys have backlight (adjustable)

**Used with:**

- CRM-V-2

**Dimensions:**

- Size (HxWxD): 11" x 4.96" x 1.18"
- Weight: 1.4 lbs

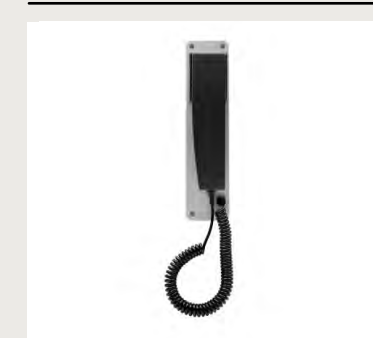

**CRM-V-HS**  
**1008097100**  
Handset for IP Flush Master CRM-V

- With 1m curly cord

**Used with:**

- CRM-V-2

**Dimensions:**

- Size (HxWxD): 11" x 2.64" x 1.6"
- Weight: 0.9 lbs



**EMBDR-8**  
**1023253008**  
Exigo Button Expansion Module, 8 Buttons

- Eight programmable buttons with individual labels and status indicators
- Optional button protection covers
- LED Indicators for power, call, and fault

**Used with:**

- ECPIR-P
- ECPIR-3P

**Dimensions:**

- Size (HxWxD): 5.7" x 3.8" x 2"
- Weight: 1.1 lbs



**EAPIR-8**  
**1023201008**  
EXIGO Alarm Panel, 8 buttons

- Eight programmable buttons with individual labels and status indicators
- Optional button protection covers
- LED Indicators for power, call, and fault

**Used with:**

- ECPIR-P
- ECPIR-3P

**Dimensions:**

- Size (HxWxD): 5.7" x 3.8" x 2"
- Weight: 1.1 lbs

## Back Boxes and Mounting Brackets



**1490009006**  
Wall Mount Bracket for ITSV-4

**Used with:**

- ITSV-4

**Dimensions:**

- Size (HxWxD): 5.9" x 5.3" x 1.7"
- Weight: 0.2 lbs



**1490009007**  
Wall Mount Bracket for ITSV-5

**Used with:**

- ITSV-5

**Dimensions:**

- Size (HxWxD): 5.8" x 5.3" x 7.55"
- Weight: 0.2 lbs



**1008091100**  
Wall Bracket for Desktop Stations

**Used with:**

- IPDM-V2
- IPDMH-V2
- IPDMHB-V2

**Dimensions:**

- Size (HxWxD): 3.6" x 4.3" x 1.8"
- Weight: 0.45 lbs



**1008098600**  
On-wall back box for IP Flush Master Stations

**Used with:**

- CRM-V-2

**Dimensions:**

- Size (HxWxD): 11" x 4.9" x 1.3"
- Weight: 0.45 lbs



**1008098700**  
Flush Mount Back Box IP Flush Master Stations

**Used with:**

- CRM-V-2
- CRM-V-DAK48
- IP-CROR

**Dimensions:**

- Size (HxWxD): 10.6" x 4.55" x 1.55"
- Weight: 1.1 lbs



**1008098800**  
Flush Mount Back Box CRM-V-HS

**Used with:**

- CRM-V-HS

**Dimensions:**

- Size (HxWxD): 10.6" x 2.3" x 1.55"
- Weight: 0.65 lbs



**2810021001**  
Wall-mount Backbox for Cleanroom Station

**Used with:**

- IP-CROR

**Dimensions:**

- Size (HxWxD): 11.6" x 5.55" x 2.55"
- Weight: 2 lbs



**2810020006**  
Single Desk Stand for IP Flush Master Stations

**Used with:**

- CRM-V-2
- CRM-V-DAK48

**Dimensions:**

- Size (HxWxD): 13.6" x 6.1" x 6.4"
- Weight: 1.75 lbs



**2810020005**  
Dual Desk Stand for CRM-V-2 and Handset

**Used with:**

- CRM-V-2
- CRM-V-HS

**Dimensions:**

- Size (HxWxD): 13.6" x 8.9" x 5.4"
- Weight: 2.85 lbs



**2810020004**  
Triple Desk Stand for IP Flush Master Stations

**Used with:**

- CRM-V-2
- CRM-V-DAK48
- CRM-V-HS

**Dimensions:**

- Size (HxWxD): 13.6" x 13.6" x 5.4"
- Weight: 4 lbs



**EMBR-1**  
**1023595010**  
Mounting Box for ECPIR, EAPIR and EBM-DR-8 Panels

**Used with:**

- ECPIR-3P
- ECPIR-P
- EAPIR-8
- EBMDR-8

**Dimensions:**

- Size (HxWxD): 4.1" x 7.4" x 2.9"
- Weight: 0.8 lbs



**EMBR-2**  
**1023595020**  
Mounting Box for ECPIR, EAPIR and EBM-DR-8 Panels

**Used with:**

- ECPIR-3P
- ECPIR-P
- EAPIR-8
- EBMDR-8

**Dimensions:**

- Size (HxWxD): 7.9" x 7.4" x 2.9"
- Weight: 1.55 lbs

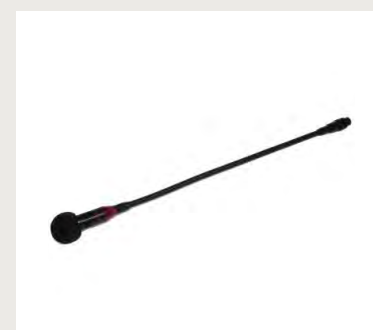

**MB-30G**  
**3005020033**  
Gooseneck Microphone

**Used with:**

- ECPIR-P
- ECPIR-3P

**Dimensions:**

- Size (Length): 17.55"
- Weight: 0.2 lbs



**PAM1H**  
**1023533012**  
Handheld Microphone for ECPIR Indoor Access Panels / Intercom Stations

**Used with:**

- ECPIR-P
- ECPIR-3P

**Dimensions:**

- Size: Length 5.6", Head 1.15", Body 0.95"
- Weight: 0.45 lbs

## Microphones



**CRM-V-GN**  
**1008097500**  
Gooseneck Microphone for IP Flush Master CRM-V-2

**Used with:**

- CRM-V-2

**Dimensions:**

- Size (HxWxD): 1.25" x 3.55" x 1.75"
- Weight: 0.2 lbs



**CRM-VH**  
**2213100000**  
Headset Solution for IP Flush Master CRM-V-2

**Used with:**

- CRM-V-2

**Dimensions:**

- Size (HxWxD): 3.8" x 3.8" x 3.15"
- Weight: 0.55 lbs

## Miscellaneous



**EMBR-6**  
**1023595060**  
Connection Kit for EMBR-1 and EMBR-2

**Used with:**

- EMBR-1
- EMBR-2

**Dimensions:**

- Weight: 0.2 lbs



# Industrial & EX IP Intercom

## Industrial Intercom

### Key Features

- **Rugged, Heavy-Duty Construction** - Built to withstand most chemical and environmental hazards found on- or offshore, extreme industrial conditions and rough handling.
- **Exceptional audio technology** - high sound pressure level (SPL), automatic volume gain control, and active noise and echo canceling ensures clear communication in noisy industrial settings.
- **Weatherproof & Dustproof** - IP-rated enclosures protect against dust, dirt, water, and extreme temperatures.
- **Hands-Free & PTT (Push-to-Talk) Options** - Enables flexible communication methods based on operational needs.
- **Emergency Call & Alarm Integration** - Can be linked to emergency systems for rapid response in critical situations.
- **Glove-Friendly & Easy-to-Use Interfaces** - Designed for operation in industrial environments, even with protective gear.

ZENITEL CONNECT PRO **ICX-AlphaCom** **IC-EDGE** SIP **OnVIF**

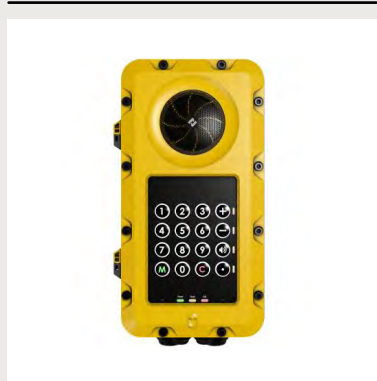

TFIE-1  
1008122010  
Industrial Intercom

- Full keypad with 1 programmable button + keys for manual override (PTT) and Cancel.
- Visible status indicators on front panel

IP66

**Dimensions:**  
• Size (HxWxD): 13.6" x 4.65" x 3.95"  
• Weight: 4.2 lbs

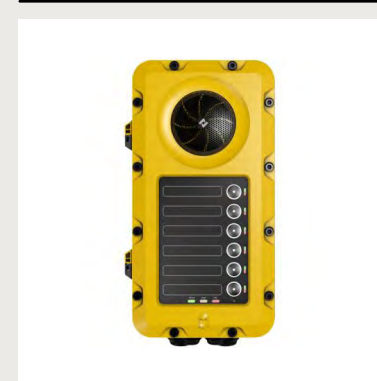

TFIE-2  
1008122020  
Industrial Intercom

- 6 programmable, labelled buttons and optional key covers for alarm panel duties.
- Visible status indicators on front panel

IP66

**Dimensions:**  
• Size (HxWxD): 13.6" x 4.65" x 3.95"  
• Weight: 4.2 lbs

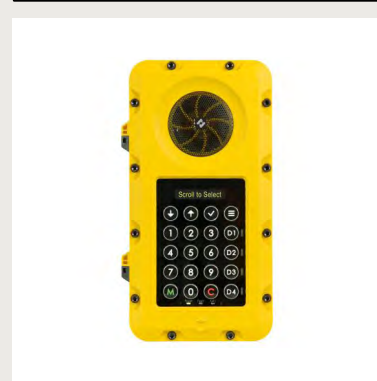

TFIE-6  
1008122060  
Industrial Intercom

- Full keypad with 4 programmable buttons, keys for manual override (PTT) and Cancel, plus display with scrolling unit.
- Visible status indicators on front panel
- PMOLED display

IP66

**Dimensions:**  
• Size (HxWxD): 13.6" x 4.65" x 3.95"  
• Weight: 4.2 lbs

# Ex IP Intercom

## Key Features

- **Explosion-Proof** - Designed for use in potentially explosive atmospheres, meeting ATEX Zone 1 and IECEx requirements for safe and reliable operation.
- **Flameproof Design** - Prevents ignition of hazardous substances in the surrounding environment.
- **Rugged, Heavy-Duty Construction** - Built to withstand most chemical and environmental hazards found on- or offshore, extreme industrial conditions and rough handling.
- **Exceptional audio technology** - high sound pressure level (SPL), automatic volume gain control, and active noise and echo canceling ensures clear communication in noisy industrial settings
- **Weatherproof & Dustproof** - IP-rated enclosures protect against dust, dirt, water, and extreme temperatures.
- **Hybrid Support** - Available in both IP and analog versions for flexible integration.

ZENITEL CONNECT PRO ICX-AlphaCom IC-EDGE SIP ONVIF



**TFIX-1-V2**  
**1008123110**  
Ex IP Intercom Station- full keypad

- Full keypad with 1 programmable key
- Visible status indicators on front panel



**Dimensions:**  
• Size (HxWxD): 13.6" x 4.65" x 3.95"  
• Weight: 8.8 lbs



**TFIX-2-V2**  
**1008123120**  
Ex IP Intercom Station with 6 buttons

- 6 programmable buttons
- Visible status indicators on front panel



**Dimensions:**  
• Size (HxWxD): 13.6" x 4.65" x 3.95"  
• Weight: 8.8 lbs

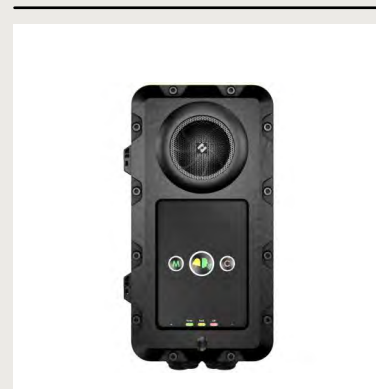

**TFIX-3-V2**  
**1008123130**  
Ex IP Intercom Station with 3 buttons

- Features 1 oversized call-button and keys for manual override (PTT) and Cancel.
- Visible status indicators on front panel



**Dimensions:**  
• Size (HxWxD): 13.6" x 4.65" x 3.95"  
• Weight: 8.8 lbs

# Industrial & EX IP Intercom Accessories

## Microphones

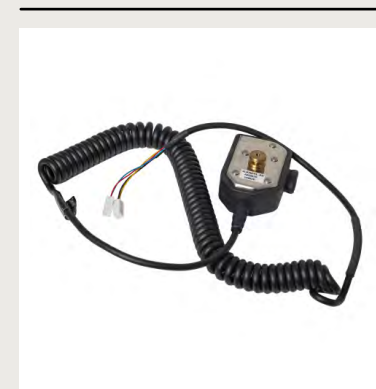

**EMMAI-2H**  
**1023533312**  
Handheld Compact Industrial Microphone For Exigo/Turbine

**Used with:**

- TFIE-1
- TFIE-2
- TFIE-6



**Dimensions:**  
• Size (HxWxD): 2.7" x 1.75" x 0.85"  
• Cable length: 2.45' / 6.55' (extended)  
• Weight: 0.5 lbs



**EMMAX-1H**  
**1023533511**  
Handheld Industrial EX Microphone For Exigo/Turbine

**Used with:**

- TFIX-1-V2
- TFIX-2-V2
- TFIX-3-V2



**Dimensions:**  
• Size (HxWxD): 2.7" x 1.75" x 0.85"  
• Cable length: 2.45' / 6.55' (extended)  
• Weight: 0.5 lbs

# Head- and Handsets



**TAX-2B**  
**1008150025**  
 Ex-Approved Plugbox and Cable for Headset with PTT

- Used with:**
- TFI-1-V2
  - TFI-2-V2
  - TFI-3-V2
  - AK5850HS

**IP67**

- Dimensions:**
- Cable length: 32.8'



**TA-22B**  
**1008140225**  
 Industrial Plugbox and Cable for Headset with PTT

- Used with:**
- TFI-1
  - TFI-2
  - TFI-6
  - AK5850HS

**IP67**

- Dimensions:**
- Cable length: 32.8'



**AK5850HS**  
 Ex-approved Headset

- Used with:**
- TFI-1
  - TFI-2
  - TFI-6
  - TAX-2B
  - TA-22B
  - TFI-1-V2
  - TFI-2-V2
  - TFI-3-V2

- Dimensions:**
- Size (HxWxD): 8.25" x 2.6" x 2.75"
  - Weight: 0.9 lbs

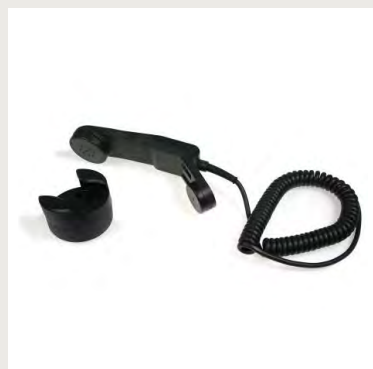

**TA-23**  
**1008140230**  
 Industrial Handset for Turbine with PTT

- Used with:**
- TFI-1
  - TFI-2
  - TFI-6

**IP66**

- Dimensions:**
- Size (HxWxD): 70 x 200 x 50mm
  - Cable Length: 1.0 m / 3.5 m (extended)

# Power Supply - Flowire Converter

## Flowire Converter

### Key Features

Flowire, based on the HomePlug AV specification, uses 24-48 V DC and acts as a network bridge between Ethernet and a PLC link.

A single-paired cable distributes both power and data, with longer runs than standard Ethernet, reducing the need for switches or repeaters. Up to nine Flowire devices can connect to the same 2-wire network. Existing infrastructure can be used, lowering retrofit project costs. The Flowire Converter works with any Ethernet-enabled device, not just Zenitel products.

The Flowire Converter enables Ethernet and power to run on the same two wires, simplifying cabling and allowing longer runs.

All Zenitel outdoor intercom stations can use the 2-wire Flowire system to extend Ethernet connections and support power distribution.



**FCDC3**  
**1008080310**  
 Flowire Ethernet Converter - DC Voltage

- The cable hauls can be longer, up to 2 km, reducing the need for switches and/or repeaters
- Enable/Disable PoE switch
- **Important!** 24-48V DC non-PoE Ex equipment

- Dimensions:**
- Size (HxWxD): 2.9" x 4.4" x 1"
  - Weight: 0.65 lbs



**Power Supply**  
**2990101120**  
 XP Power Supply, 48Vdc 120W

- Up to 90% Efficiency
- Wide Adjustment Range
- Parallel Function
- DC Standby Versions
- Full Power from -40 °F to +140 °F
- Connector Options

- Dimensions:**
- Size (HxWxD): 4.9" x 2.5" x 4.55"
  - Weight: 2 lbs



**Power Supply**  
**2990101240**  
 XP Power Supply, 48Vdc 240W

- Up to 90% Efficiency
- Wide Adjustment Range
- Parallel Function
- DC Standby Versions
- Full Power from -40 °F to +140 °F
- Connector Options

- Dimensions:**
- Size (HxWxD): 4.9" x 3.25" x 4.4"
  - Weight: 3 lbs

# Heavy-Duty IP Stations

## Key Features

- **Exceptional audio performance** - High sound pressure level (SPL), automatic volume gain control, and active noise and echo canceling ensures clear communication in noisy industrial settings
- **Impact-Resistant Construction** - Built-in, 5 mm aluminum casing and stainless steel components to withstand rough handling and heavy industrial use.
- **IP-Rated for Harsh Environments** - Weatherproof and dustproof, ensuring reliable operation in extreme conditions.
- **Analog & Hybrid Options** - Supports both modern and legacy communication systems. Additionally, the heavy-duty stations offer an option for GSM cellular connectivity for increased flexibility in deployment.
- **Push-to-Talk (PTT) and Hands-Free Operation** - Provides flexibility for different use cases.
- **Emergency Call and Alarm Integration** - Can be connected to safety and security systems for rapid response. Supports a wide set of IP and networking standards.

ZENITEL CONNECT PRO ICX-AlphaCom IC-EDGE SIP Onvif

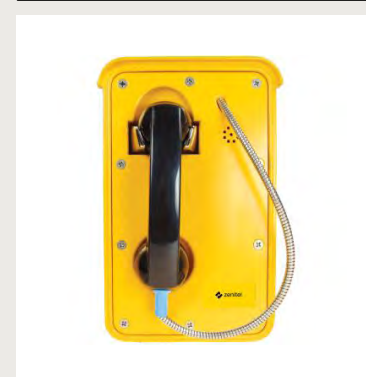

**IPHDT-Y**  
**1008472120**  
IP Heavy Duty Telephone, Armored 50cm Cord, Yellow

- Hotline telephone, without door

IP66

#### Dimensions:

- Size (HxWxD): 12.6" x 8.05" x 4.7"
- Weight: 11 lbs

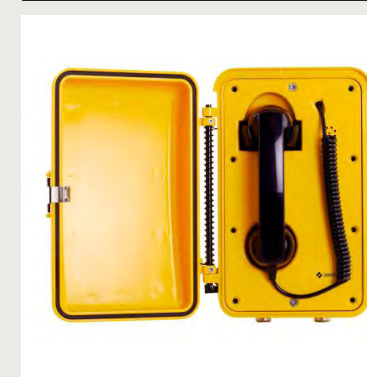

**IPHDT-DY**  
**1008472220**  
IP Heavy Duty Telephone, Door, Coiled Rubber Cord, Yellow

- Hotline telephone, with door

IP66 IK10

#### Dimensions:

- Size (HxWxD): 12.6" x 8.05" x 5.8"
- Weight: 11.9 lbs

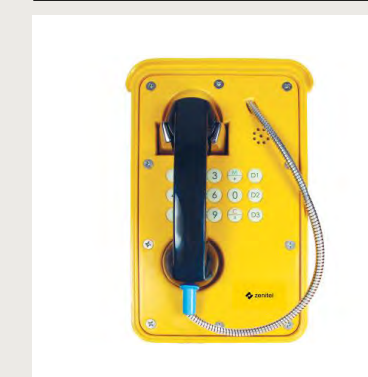

**IPHDT-KY**  
**1008472100**  
IP Heavy Duty Telephone, Keypad, Armored 50cm Cord, Yellow

- Full keyboard with 3 programmable buttons

IP66

#### Dimensions:

- Size (HxWxD): 12.6" x 8.05" x 4.7"
- Weight: 11 lbs

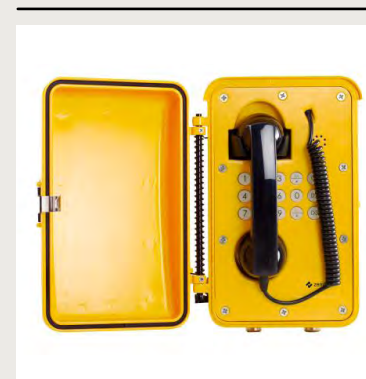

**IPHDT-KDY**  
**1008472200**  
IP Heavy Duty Telephone, Door, Coiled Rubber Cord, Yellow

- Full keyboard with 3 programmable buttons, with door

IP66 IK10

#### Dimensions:

- Size (HxWxD): 12.6" x 8.05" x 5.8"
- Weight: 11.9 lbs

# Public Address & Voice Alarm (PAVA)

Zenitel PAVA combines voice alarm/evacuation and operational public address in a unified system, with supervised audio paths and fault reporting to support dependable operation.

## Technical scope

- Public address and paging announcements for operational communication.
- Voice alarm/voice evacuation messaging with prioritised emergency handling.
- Support for emergency microphones and controlled live announcements.
- Zoned messaging and site-wide broadcasts with supervised signal paths.

## System Architecture (examples)

- VIPEDIA audio router platform with IP audio capabilities and general-purpose I/O.
- Supports redundant and supervised audio networking and scalable multi-node deployments (clustered systems) with fault reporting.
- Compatible with Zenitel amplifier ranges (e.g., V2000/V400) as part of the Zenitel PAVA system.

## Compliance & integration

- EN 54-16 aligned architectures for regulated installations. Certification depends on project scope and selected components.
- Fire alarm and life-safety interfaces for automated emergency triggering.
- Integration into wider security workflows (e.g., via Zenitel Connect Pro or third-party automation) for operational and security announcements.
- Optional integration with Zenitel Connect Pro (requires Zenitel Connect Pro on ICX-510) to trigger selected PAVA functions from operator workflows (where applicable).

*\*Vipedia and Integra products are pending UL certification for the US market.*

Within this catalog, only a select few core products are showcased. For our full range, visit [zenitel.com/product/safety-security/public-address-voice-alarm-pava-solutions](https://zenitel.com/product/safety-security/public-address-voice-alarm-pava-solutions).



INTEGRA-00 - 10

Wall Mount PAVA System (0-10 amp channels pre-installed)

- Self-contained wall mount PAVA System
- Up to 2000W load total
- 24 bit 48kHz audio processing
- 12 analogue audio inputs & outputs / 6 IP audio inputs
- Pre-installed with 3, 5, 7 or 10 amplifier cards
- Interoperable with the Vipedia range

**Dimensions:**  
 • Size (HxWxD): 38.6" x 23.6" x 8.7"  
 • Weight: 88.2 lbs



INTEGRA-PRO-00 - 10

Wall Mount PAVA System (0-10 amp channels pre-installed) - Dante Enabled

- Self-contained wall mount PAVA System
- Up to 2000W load total
- 24 bit 48kHz audio processing
- 12 analogue audio inputs & outputs / 6 IP audio inputs
- Pre-installed with 3, 5, 7 or 10 amplifier cards
- Interoperable with the Vipedia range

**Dimensions:**  
 • Size (HxWxD): 38.6" x 23.6" x 8.7"  
 • Weight: 88.2 lbs



VIPEDIA-12-NET

1200100012  
 PAVA Audio router with network card

- Fully EN 54-16 certified
- 24 bit 48kHz audio processing
- 12 analogue audio inputs & outputs / 6 IP audio inputs
- Up to 32 units can be grouped together
- Compatible with the V2000 and V400 amplifier ranges

**Dimensions:**  
 • Size (HxWxD): 1.65" x 17.2" x 16.8"  
 • Weight: 8.3 lbs

*\*Vipedia and Integra products are pending UL certification for the US market.*



VIPEDIA-12-PRO

1200100121  
 PAVA Audio router with network card - Dante Enabled

- Fully EN 54-16 certified
- 24 bit 48kHz audio processing
- 12 analogue audio inputs & outputs / 6 IP audio inputs
- Up to 32 units can be grouped together
- Compatible with the V2000 and V400 amplifier ranges

**Dimensions:**  
 • Size (HxWxD): 1.65" x 17.2" x 16.8"  
 • Weight: 8.3 lbs



V2000

1200202000  
 PAVA 2000W Power Amplifier Mainframe (0 amps pre-installed)

- Up to 2000W in 2U / 19" housing
- EN 54-16 and EN 54-4 compliant
- Houses up to 10 separate amplifier cards
- Hot-swappable amplifiers cards
- Integrated battery charger
- Internal & external standby options

**Dimensions:**  
 • Size (HxWxD): 3.4" x 17.2" x 16.7"  
 • Weight: 17 lbs



D150

1200202150  
 PAVA 150W Power Amplifier Module for the V2000 / INTEGRA

- Fully EN 54-16 certified
- Class D transformerless amplifiers
- 100V, 70V or 50V output
- Compatible with the V2000 mainframe and Integra range Pre-installed with 3, 5, 7 or 10 amplifier cards

**Dimensions:**  
 • Weight: 1.8 lbs



**D500**  
**1200202500**  
PAVA 500W Power Amplifier Module for the V2000 / INTEGRA

- Fully EN 54-16 certified
- Class D transformerless amplifiers
- 100V, 70V or 50V output
- Compatible with the V2000 mainframe and Integra range Pre-installed with 3, 5, 7 or 10 amplifier cards

**Dimensions:**

- Weight: 1.8 lbs



**LSZDC**  
**1200540000**  
PAVA Amplifier Interface Module for the V2000 / INTEGRA

- EN 52-16 certified amplifier interface card
- Powerful on-board DSP capability
- DC / impedance / loop monitoring (A to B)
- Independently monitored A / B line output fed from a single amplifier
- Compatible with the V2000 mainframe and Integra range

**Dimensions:**

- Weight: 0.8kg

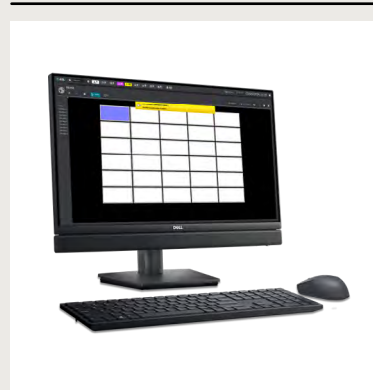

**VIPA-WS**  
**1200450150**  
Public Address Touch Screen Workstation

- Versatile and intuitive public address control and supervision front end
- Supports up to 384 PAVA zones
- Live paging
- PAVA system audio monitoring and supervision
- Message management, recording, playback and scheduling

## SIP Amplifiers

### Key Features

- **Superior Audio Performance** - High-power output, wide frequency response, and low-latency audio processing ensure strong, clear sound for effective communication, even in large or noisy environments.
- **SIP & IP-Based Connectivity** - Easily integrates with VoIP systems, intercoms, and PAVA solutions.
- **Multicast and Unicast Support** - Enables efficient audio distribution across large sites.
- **Industrial-Grade Build** - Designed for reliable operation in harsh environments.
- **Failover & Redundancy Support** - Ensures continuous operation, even with network issues.

SIP



**EMS01 - EMS50**

Wall Mount Emergency Mic

- Equipped with single PTT and up to 50 physical buttons
- EN 54-16 compliant indicators and controls
- Live, store +forward & recorded broadcasts
- Built-in loudspeaker with listen-in function

IP65

**Dimensions:**

- Size (HxWxD): 15.8" x 13.5" x 3.7"
- Weight: 13.2 lbs



**MPS01-G - MPS50-G**

Desk Mount Paging and Emergency Mic with PTT - Gooseneck - IP enabled

- Equipped with single PTT and up to 50 physical buttons
- EN 54-16 compliant indicators and controls
- Live, store +forward & recorded broadcasts
- Built-in loudspeaker with listen-in function
- Wall mount and fist microphone

**Dimensions:**

- Size (HxWxD): 2.3" x 6.9" x 7.9"
- Weight: 2.2 lbs



**ENA2100-AC2**  
**1023102110**  
Exigo Network Amplifier 2 x 100W AC

- 2x 100 watt continuous GA power

**Dimensions:**

- Size (HxWxD): 3.4" x 18.95" x 14.65"
- Weight: 23.6 lbs



**ENA2200-AC2**  
**1023102210**  
Exigo Network Amplifier 2 x 200W AC

- 2x 200 watt continuous GA power

**Dimensions:**

- Size (HxWxD): 3.4" x 18.95" x 14.65"
- Weight: 24.7 lbs

# PAVA Accessories

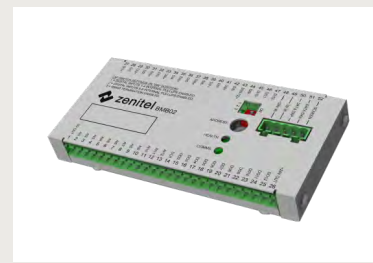

**BMB02**  
**1200550031**  
Din Rail Mount I/O Expansion Device

- Low profile DIN rail mount casing
- Expands the capability of the audio router
- 12 analog inputs
- 12 digital (opto-isolated) inputs
- 12 digital (open collector) outputs
- Up to 9 units can be connected in parallel

**Used with:**

- VIPEDIA-12 Range
- INTEGRA Range

**Dimensions:**

- Size (HxWxD): 3.6" x 6.3" x 1.7"
- Weight: 0.8 lbs

*\*Vipedia and Integra products are pending UL certification for the US market.*



**ANS04-ES**  
**1200500040**  
Wall Mount Sample and Hold Ambient Noise Sensor

- Sample and hold noise sensor
- Extended temperature range
- Fail safe operation

**IP65**

**Used with:**

- VIPEDIA-12 Range
- INTEGRA Range

**Dimensions:**

- Size (HxWxD): 6.3" x 3.9" x 3.2"
- Weight: 2.16 lbs



**DANS01**  
**1200500010**  
Wall Mount Dynamic Ambient Noise Sensor

- Dynamic noise sensor
- Extended temperature range
- Fail safe operation

**IP65**

**Used with:**

- VIPEDIA-12 Range
- INTEGRA Range

**Dimensions:**

- Size (HxWxD): 6.3" x 3.9" x 3.2"
- Weight: 2.16 lbs



**MPX10**  
**1200571067**  
Expansion Module for MPS01 with 10 buttons

- Easy to install expansion module with fittings
- Add additional 10 physical buttons

**Used with:**

- MPS range of microphones

**Dimensions:**

- Size (HxWxD): 2.3" x 11.2" x 7.9"
- Weight: 2.65 lbs



**RAK-DUCT-01**  
**1200571000**  
Cooling Duct 1U for the V2000

- Optimum V2000 cooling
- Standard 19" rack installations

**Used with:**

- VIPEDIA-V2000 Range
- RAK-FAN-01

**Dimensions:**

- Size (HxWxD): 1.75" x 19" x 10.4"
- Weight: 2.9 lbs

*\*Vipedia and Integra products are pending UL certification for the US market.*



**RAK-FAN-01**  
**1200542001**  
Fan Shelf 1U for the V2000

- Optimum V2000 cooling
- Standard 19" rack installations

**Used with:**

- VIPEDIA-V2000 Range
- RAK-DUCT-01

**Dimensions:**

- Size (HxWxD): 1.75" x 19" x 10.4"
- Weight: 5.3 lbs



**VIPEDIA-BOA01**  
**1200550010**  
Din Rail Mount RJ45 Breakout Adapter - Single Port

- Break out of all of the connections from one RJ45 port, to eight screw terminals plus screen terminals
- End of line monitoring resistor positions
- Additional dual redundant power inputs and output power terminals
- Additional screen connection and output cable screen terminals

**Used with:**

- VIPEDIA Range

**Dimensions:**

- Size (HxWxD): 1.3" x 3.5" x 2"
- Weight: 0.2 lbs

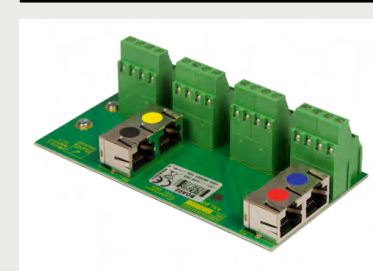

**VIPEDIA-BOA02**  
**1200550020**  
Din Rail Mount RJ45 Breakout Adapter - Four Port

- DIN rail mounted
- Break out of all of the connections from four RJ45 ports, each to eight screw terminals plus an output cable screen terminal

**Used with:**

- VIPEDIA Range

**Dimensions:**

- Size (HxWxD): 1.4" x 2.4" x 4.6"
- Weight: 0.2 lbs



**BDU01**  
**1200550033**  
PAVA Beacon Driver Unit

- DIN rail mounted
- 6 individually fused outputs 18-69 VDC

**Used with:**

- VIPEDIA Range
- INTEGRA Range
- V2000-POK01

**Dimensions:**

- Size (HxWxD): 1.6" x 9.9" x 4"
- Weight: 2.36 lbs



**V2000-POK01**  
**1200550032**  
Power Output Card Kit for V2000 or INTEGRA Frame

- Provides access to spare battery capacity in the V2000 or Integra frame
- Offers a fused DC output up to 9A @ 24 VDC
- 2 Separate Cards

**Used with:**

- VIPEDIA-V2000 Range
- INTEGRA Range
- BDU01

**Dimensions:**

- Size (HxWxD): Rear Card: 2" x 0.6" x 5.1", Front Card: 3.15" x 0.8" x 10.8"
- Weight: Rear: 0.8 lbs, Front: 0.25 lbs

# IP Speakers

## Zenitel's IP Speakers with microphone

### Key Features

- **Zenitel Audio Presence** - High with sound pressure level (SPL), wide frequency response, and advanced audio processing ensure crystal-clear audio in any setting.
- **IP-Based Connectivity** - Easily integrates into existing IP networks, enabling centralized control and monitoring.
- **Built-in Microphone** - Supports half-duplex (Push-to-Talk) audio for clear and reliable two-way communication.
- **Multicast and Unicast Support** - Supports efficient audio distribution across large sites or multiple zones.
- **Power over Ethernet (PoE)** - Simplifies installation by reducing the need for additional power sources.

ZENITEL CONNECT PRO ICX-AlphaCom IC-EDGE SIP ONVIF

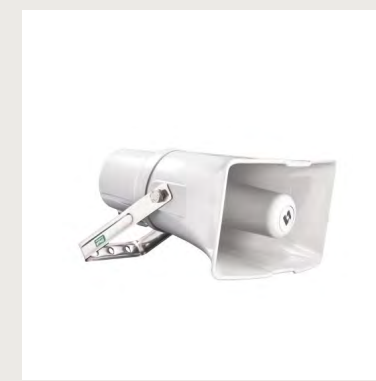

**ZIPS-H**  
**1023321311**  
 Zenitel IP Speaker - Horn

- 120 dB Max Sound Pressure Level 1kHz/1m
- 275 - 7000 Hz Frequency range

**IP66 IK08**

- Dimensions:**
- Size (HxWxD): 6" x 9.95" x 12.15"
  - Weight: 4.1"



**ZIPS-HHO**  
**1023321330**  
 Zenitel IP Speaker - Horn High Output

- 123 dB Max Sound Pressure Level 1kHz/1m
- 240 - 10000 Hz Frequency range

**IP66 IK08**

- Dimensions:**
- Size (HxWxD): 6.7" x 12.4" x 13.8"
  - Weight: 4.1 lbs



**ZIPS-C**  
**1023320011**  
 Zenitel IP ceiling speaker

- 105 dB Max Sound Pressure Level 1kHz/1m
- 250 - 10000 Hz Frequency range
- Steel fire dome

- Dimensions:**
- Size (Diameter x Depth): 7.85" x 5.75"
  - Weight: 2.65 lbs



**ZIPS-WC**  
**1023322330**  
 Zenitel IP Speaker - Wall-mount Cabinet

- 103 dB Max Sound Pressure Level 1kHz/1m
- 90 - 20000Hz (± 20%) Frequency range

**IP66**

- Dimensions:**
- Size (HxWxD): 6.3" x 10.05" x 7.45"
  - Weight: 4.65 lbs

# Emergency Stanchions, Wall Units and Surface Mount Boxes

## Emergency Communications for Safety and Security

### Key Features

- **High-Quality Audio** - Delivers clear and intelligible messages.
- **Rugged Construction** - Built to withstand vandalism and harsh conditions, ensuring long-term durability.
- **Corrosion-Resistant Coating** - Designed to withstand prolonged exposure to harsh environments.
- **ADA Compliant** - Fully meets all ADA requirements for accessibility.
- **Customizable Design** - Available in various colors, signage, and lettering to match customer specifications.
- **Flexible Power Options** - Supports 120 VAC, 12/24 VDC, and 24 VAC power inputs.
- **Versatile Loudspeaker Mounting** - IP speakers can be mounted both internally and externally for optimal broadcast coverage.
- **Configurable LED lights** - Blue LED lights can be set to remain continuously lit or flash when a call is placed via the intercom.



Emergency Communication Tower /  
Stanchion 1600 Deluxe Tower  
**2809016000**  
1600 Deluxe Tower

- Easy to install, versatile, modular design

#### Dimensions:

- Size (HxWxD): 9' x 1' x 10"
- Weight: 340 lbs



Emergency Communication Tower /  
Stanchion 1600 Tower  
**2809016002**  
1600 Tower with Mass Notification

- LED blue light flashes when unit is activated - LED blue light is constantly on
- Integrated emergency and wide-area emergency broadcast system
- Concealed, high-power speakers provide 360° coverage

#### Dimensions:

- Size (HxWxD): 10.33' x 12.75" x 11"
- Weight: 430 lbs



Emergency Communication Tower /  
Stanchion 1600-04  
**2809016004**  
1600-04 Tower with Optional 4 CCTV Mount

- CCTV arm for holding of dome camera (not included)
- Camera mount provides high vantage point for surveillance cameras

#### Dimensions:

- Size (HxWxD): 11.9' x 1' x 10"
- Weight: 395 lbs



Emergency Communication Tower /  
Stanchion 1600-04 with Mass Notification  
**2809016006**  
1600-04 Tower - CCTV Mount & Mass Notification

- CCTV arm for holding of dome camera (not included)
- Camera mount provides high vantage point for surveillance cameras
- Integrated emergency and wide-area emergency broadcast system
- Concealed, high-power speakers provide 360° coverage

**Dimensions:**

- Size (HxWxD): 11.94' x 12" x 10"
- Weight: 485 lbs



Emergency Communication Tower /  
Stanchion 1608  
**2809016080**  
1608 Eco Tower

- Easy to install, versatile, modular design
- Lightweight aluminum construction, which allows for one person installation

**Dimensions:**

- Size (HxWxD): 9.4' x 10" x 6.8"
- Weight: 45 lbs



Emergency Communication Tower /  
Stanchion 1601  
**2809016010**  
1601 EconoTower

- Easy to install, versatile, modular design

**Dimensions:**

- Size (HxWxD): 9.6' x 10" x 8"
- Weight: 300 lbs



Emergency Communication Wall Unit  
1602  
**2809016029**  
1602 Deluxe Wall Unit Slim

- Mounts to wall or straps to pole or kiosk
- 2-inch high, reflective red "EMERGENCY" lettering

**Dimensions:**

- Size (HxWxD): 32" x 10" x 4"
- Weight: 23 lbs



Emergency Communication Wall Unit  
1602  
**2809016022**  
1602 Wall Unit with Mass Notification

- Integrated emergency and wide-area emergency broadcast system. Two 40-watt speakers with 33-watt amplifier.
- Mounts to wall or straps to pole or kiosk
- 2-inch high, reflective red "EMERGENCY" lettering.

**Dimensions:**

- Size (HxWxD): 31.9" x 10.7" x 8.2"
- Weight: 50 lbs



Emergency Communication Wall Unit  
1603  
**2809016030**  
1603 Economy Wall Unit

- Mounts to wall or straps to pole or kiosk

**Dimensions:**

- Size (HxWxD): 32" x 10" x 8"
- Weight: 41 lbs



Emergency Communication Tower /  
Stanchion 1604  
**2809016040**  
1604 72" Tower

- Easy to install, versatile, modular design
- Lightweight construction, which allows for one person installation

**Dimensions:**

- Size (HxWxD): 6' x 10" x 8"
- Weight: 30 lbs



Emergency Communication Wall Unit  
1602  
**2809016020**  
1602 Deluxe Stanchion Wall Unit

- Mounts to wall or straps to pole or kiosk
- 2-inch high, reflective red "EMERGENCY" lettering

**Dimensions:**

- Size (HxWxD): 32" x 10.5" x 8"
- Weight: 41 lbs



Emergency Communication Wall Unit  
1602 with Turbine Cut-Out  
**2809016028**  
1602 Deluxe Wall Unit Slim with Turbine Cut-Out

- Mounts to wall or straps to pole or kiosk
- 2-inch high, reflective red "EMERGENCY" lettering
- Cut-Out for intercom series TCIS, TCIV+, and TCAS

**Dimensions:**

- Size (HxWxD): 32" x 10" x 4"
- Weight: 23 lbs



Emergency Communication Wall Unit  
1603 with Turbine Cut-Out  
**2809016038**  
1603 Economy Wall Unit Slim with Turbine Cut-Out

- Mounts to wall or straps to pole or kiosk
- 2-inch high, reflective red "EMERGENCY" lettering
- Cut-Out for intercom series TCIS, TCIV+, and TCAS

**Dimensions:**

- Size (HxWxD): 32" x 10" x 4"
- Weight: 23 lbs



Emergency Communication Wall Unit  
1603  
**2809016039**  
1603 Economy Wall Unit Slim

- Mounts to wall or straps to pole or kiosk
- 2-inch, high-reflective red "EMERGENCY" lettering

**Dimensions:**

- Size (HxWxD): 32" x 10" x 4"
- Weight: 23 lbs

# Emergency Stanchions, Wall Units, and Surface Mount Box Accessories



1600 Turbine Plate w/ TA-18 USA  
**107216008140**  
 Stainless Steel Faceplate with Flush-Mount Backbox

**Used with:**

- TCIS Series
- TCIV+ Series
- TCAS Series
- Emergency Communication Towers/ Stanchions
- Emergency Communication Wall Units

**Dimensions:**

- Size (HxWxD): 9.1" x 5.95" x 4"
- Weight: 3.3 lbs



Stainless Steel Backbox  
**1072104900**  
 With Hood, Yellow

**Used with:**

- TCIS Series
- TCIV+ Series
- TCAS Series
- Emergency Communication Towers / Stanchions
- Emergency Communication Wall Units

**Dimensions:**

- Size (HxWxD): 10.5" x 12.8" x 6.5"
- Weight: 13 lbs



Stainless Steel Backbox  
**1072104000**  
 No hood, yellow

**Used with:**

- TCIS Series
- TCIV+ Series
- TCAS Series
- Emergency Communication Towers / Stanchions
- Emergency Communication Wall Units

**Dimensions:**

- Size (HxWxD): 10.5" x 12.7" x 3.7"
- Weight: 8 lbs



Stainless Steel Backbox  
**1072104300**  
 With Hood

**Used with:**

- TCIS Series
- TCIV+ Series
- TCAS Series
- Emergency Communication Towers / Stanchions
- Emergency Communication Wall Units

**Dimensions:**

- Size (HxWxD): 10.5" x 12.8" x 6.5"
- Weight: 13 lbs

## IP Station Kits

Zenitel's IP Station Kits provide a comprehensive communication solution, designed for quick installation and seamless integration into existing IP networks. Ideal for intercom systems, entry points, public address, and security applications across various industries, these kits offer robust functionality and deliver the superior audio quality that Zenitel intercoms are known for.

### Key Features

- **Exceptional audio technology** - High sound pressure level (SPL), automatic volume gain control, and active noise and echo canceling ensure clear communication in noisy industrial settings.
- **Pre-Configured for Easy Deployment** - Ready to be connected to your network with minimal configuration required.
- **Flexible Communication Options** - Supports full open duplex provides free-flowing, hands-free communication or push-to-talk (PTT) communication, depending on your operational needs.
- **IP-Based Connectivity** - Easily integrates into existing IP networks, enabling remote management and monitoring.
- **Cybersecurity Hardened** - Designed with built-in security features to prevent unauthorized access and protect communication.

ZENITEL CONNECT PRO

ICX-AlphaCom

IC-EDGE

SIP

ONVIF



**ZMK-1**  
**1008560101**  
Zenitel Multipurpose Kit

- Dual RJ45 for PoE and Ethernet connectivity (with switch)
- 2 configurable inputs and outputs to activate door openers and sensors
- High-quality and high-power 15W audio amplifier
- Wide selection of open standard connectors and interfaces such as USB, HDMI, and dry contacts

**Dimensions:**

- Size (HxWxD): 1.45" x 6.05" x 2.8"
- Weight: 0.7 lbs



**TKIE-1**  
**1008132010**  
Turbine Extended IP Kit

- Dual RJ45 for PoE and Ethernet connectivity (with switch)
- Dual relays (DPDT)
- Possibility for connecting high-power relay module (TA-10)

**Dimensions:**

- Size (HxWxD): 2.5" x 3.95" x 1"
- Weight: 0.2 lbs



**TKIE-2**  
**1008132020**  
Turbine Extended IP Kit

- Dual RJ45 for PoE and Ethernet connectivity (with switch)
- Dual relays (DPDT)
- Possibility for connecting high-power relay module (TA-10)

**Dimensions:**

- Size (HxWxD): 2.9" x 4.15" x 1.2"
- Weight: 0.2 lbs



**TKIS-1CC**  
**1008131015**  
TKIS-1, Conformal coated

- Standard IP Kit with Zenitel's audio technology and support of a wide set of IP and networking standards
- Conformal coating

**Dimensions:**

- Size (HxWxD): 2.55" x 3.95" x 1"
- Weight: 0.2 lbs



**TKIS-2**  
**1008131020**  
Audio Intercom Kit

- DIN-rail mountable, clips included

**Dimensions:**

- Size (HxWxD): 1.25" x 4.6" x 2.8"
- Weight: 0.2 lbs



**TKIS-2CC**  
**1008131025**  
TKIS-2, Conformal coated

- DIN-rail mountable, clips included
- Conformal coating

**Dimensions:**

- Size (HxWxD): 1.25" x 4.6" x 2.8"
- Weight: 0.2 lbs



**TKIE-3CC**  
**1008132035**  
Turbine Extended IP Kit with Keyscan

- 5x5 key-scan matrix
- Dual RJ45 for PoE and Ethernet connectivity (with switch)
- Dual relays (DPDT)
- Possibility for connecting high-power relay module (TA-10)
- Conformal coating

**Dimensions:**

- Size (HxWxD): 2.5" x 3.95" x 1"
- Weight: 0.2 lbs



**TKIV+**  
**1008331010**  
Turbine Video - VoIP Intercom Module

- HD video up to 1080p resolution
- Wide angle lens with 180 degrees field of view horizontally and vertically
- High performance hardware platform with 4 x Cortex-A53 CPU cores and 512MB LPDDR4 RAM

**Dimensions:**

- CPU Size (HxWxD): 3.5" x 4.25" x 1.2"
- Video module Size: 3.5" x 2.6" x 1.2"



**TKIS-1**  
**1008131010**  
Turbine Kit IP Standard

- Standard IP Kit with Zenitel's audio technology and support of a wide set of IP and networking standards

**Dimensions:**

- Size (HxWxD): 2.5" x 3.95" x 1"
- Weight: 0.2 lbs

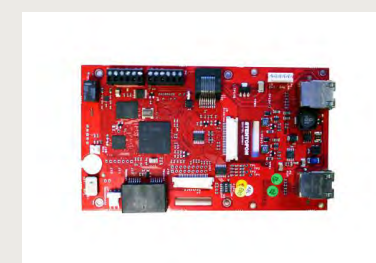

**IPMSK-V2**  
**1008493000**  
IP Master Station Kit PCB-V2

- Dual RJ45 for PoE and Ethernet connectivity (with switch)
- Supports external audio amplifier

**Dimensions:**

- Size (HxWxD): 3.46" x 5.96" x 0.8"
- Weight: 0.55 lbs

# IP Station Kit Accessories



**IP-LCM-A**  
**1008095201**  
IP Line Expansion Module with Inputs/  
Outputs

- 8 relay outputs
- 8 control inputs
- Robust push-in connectors for cables up to 1.5 mm<sup>2</sup> / 16 AWG
- Audio in/out for interfacing to other systems

**Used with:**

- TKIS-2

**Dimensions:**

- Size (HxWxD): 6" x 10.65" x 2.6"



**TA-10**  
**1008140100**  
Relay Module

- Dual high-power relays (DPDT)
- Up to 400VAC /48 VDC per relay
- Up to 6A current per relay
- Heavy-duty, spring-loaded terminals with spare grounding terminals

**Used with:**

- TKIE-1
- TFIE Series

**Dimensions:**

- Size (HxWxD): 1.96" x 3.9" x 1.5"
- Weight: 0.22 lbs



**TA-16**  
**1008140160**  
Loudspeaker

- 5 speakers included
- Maximum power: 8 W
- Nominal impedance Z: 8 Ω
- Frequency range: 120–20000 Hz
- SPL peak power: 86 dB

**IP65**

**Used with:**

- TKIE-2
- TKIS-2

**Dimensions:**

- Size (HxWxD): 2.6" x 2.6" x 1.2"
- Weight: 0.11 lbs



**TA-17**  
**1008140170**  
Electret Microphone

- 10 microphones included

**Used with:**

- TKIE-2
- TKIS-2

**Dimensions:**

- Cable length: 4.72"

# Zenitel Connect Pro

## Unified Critical Communication Platform

Zenitel Connect Pro is a software-driven unified critical communication platform that consolidates intercom, IP speakers, public address, voice alarm and general alarm systems into one system. It is designed to complement security ecosystems (e.g., VMS and access control) with unified operator workflows across sites.

### Deployment & Management

- Deployment options: dedicated ICX-510 server or OVA images for VMware.
- Web-based management: configure and operate system, devices, users, and features via Zenitel Connect Web.
- Scales from single sites to multi-site estates through modular, software-centric architecture.

### Media & Operator Workflows

- Native support for audio and video communications.
- Supports unified operator workflows that combine audio actions with security events and visual verification.

### Integration & Automation

- Open standards (device support): SIP and ONVIF.
- Zenitel Link integration interfaces: REST API + PubSub (real-time events and control), documented via OpenAPI (Swagger).
- PubSub enables event monitoring such as device online/offline, conversation state (idle/ringing/in conversation), and device I/O state changes.
- Automation: native Node-RED support for custom workflows and site logic (security and operational use cases).
- Note: Zenitel Link integrations require ZCL-API integration license (incl. ONVIF via Zenitel Link).

### Cloud Connectivity (Optional)

- Cloud Connection can be enabled in Zenitel Connect Web to support cloud-assisted monitoring and remote management.
- Requires a Zenitel cloud account.

### Cybersecurity & Hardening (high level)

- Cybersecurity is a core design criterion; requests are authorized and authenticated.
- Supports certificate handling for trusted web/server operation and secure connectivity.
- Encryption support for communications to devices and external interfaces is available in Zenitel Connect Pro software releases.

### Service & Diagnostics (capability examples)

- Extended system and device monitoring capabilities include initiating tone test and button test (software feature).
- Improved logging and reporting capabilities (including syslog support) are available in software releases.

### Optional Integrations

- Vikipedia PAVA integration is available to trigger functions within Vikipedia PAVA from Zenitel Connect Pro (configuration required).



### ICX-510

**1002000200**

Server platform for Zenitel Connect Pro

- Capacity: supports up to 50 concurrent calls and up to 200 IP devices per server.
- Robustness: dual software images to reduce downtime during upgrades.
- Security: secure boot and hardware Root of Trust.
- Networking: 2 x 1GbE interfaces.
- Form factor: compact 1U fanless, vibration-proof design; wall or 19" rack mounting.
- Power: low-power footprint (max 15 W).
- Expandability: storage expansion via MicroSD/USB.

#### Dimensions:

- Size (HxWxD): 1.75" x 6.4" x 7.85"
- Weight: 2.2 lbs

ICX-510 is Zenitel's dedicated, hardened server platform for Zenitel Connect Pro, providing the on-premises compute foundation for unified critical communications with HD voice and video support. It is designed for high uptime in demanding operational environments and supports secure operation through built-in hardware security features and hardened platform services.

## Zenitel Connect Pro Licenses



### ZCL-IC1

**1002700101**

Devices

- Each IP device connected to Zenitel Connect Pro requires this license. The maximum number of devices supported is 200.

### ZCL-API

**1002720900**

Integration

- License for integration. This is an on/off license, so only one needed.

### ZCL-PBX

**1002720100**

SIP Trunk

- License required for communicating with 3rd party iPBX and Call Managers. One per defined trunk.

### ZCC\_x64

**1002700000**

Zenitel Connect Pro Core

- License to run Zenitel Connect Pro in a supported x64 virtual environment.

### ZCUL-IC

**1002790001**

Software Maintenance Subscription

- Upgrade subscription, per device - 3 years.

### ZCL-IVAA

**1002729100**

Audio Analytics

- Intellivision Audio Analytics License. One license per device.

# Cloud Device Monitoring & Management

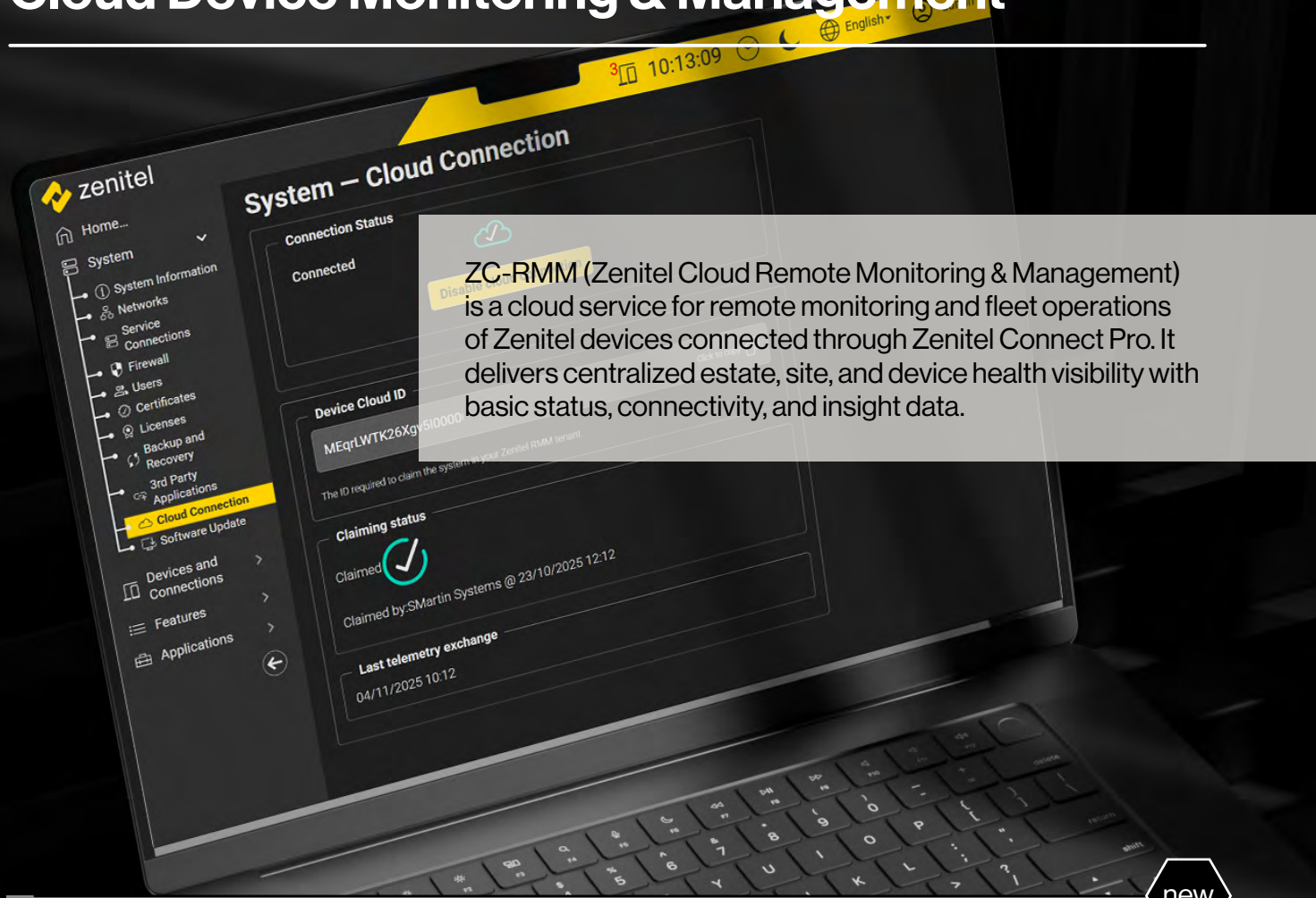

ZC-RMM (Zenitel Cloud Remote Monitoring & Management) is a cloud service for remote monitoring and fleet operations of Zenitel devices connected through Zenitel Connect Pro. It delivers centralized estate, site, and device health visibility with basic status, connectivity, and insight data.

new

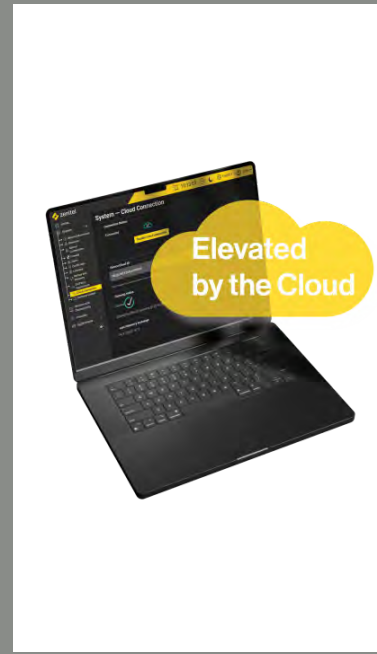

## ZC-RMM 1015909

Zenitel Cloud Remote Monitoring & Management

- Unified real-time dashboard with customizable widgets for health and trends.
- Quick onboarding via Zenitel Connect Pro using Device Cloud ID claiming.
- Multi-customer separation with tenant/customer and Space scoping plus granular role-based access.
- Operational workflows to cut downtime: guided claiming, maintenance windows, bulk actions, and history-preserving like-for-like replacement.

### Claiming Model

- Each device/system can be claimed by one organization and located in a single Space; moving between Spaces is allowed.
- Claiming is typically done per Zenitel Connect Pro system; connected endpoints are registered and presented as child devices.
- Moving a device to another customer requires deleting device history and re-claiming.

### Requirements

- Zenitel Connect Pro configured for Zenitel Cloud connection. Enable Cloud Connection in Connect Web and sign in with a Zenitel Cloud account.

### Optional Subscription Capabilities

Subscription can enable remote configuration, firmware management, and extended diagnostics.

### Security

Authenticated, encrypted communications with tenant/Space scoping and role-based, least-privilege access.

### Licensing / Ordering

Annual subscription per device. No physical product. Available through Zenitel's partner channel.



## IA-MB1 1002500020

Mounting Bracket for ICX-510/ICX-510-IA

### Used with:

- ICX-510
- ICX-510-IA

### Dimensions:

- Size (HxWxD): 1.1" x 6.65" x 7.95"
- Weight: 0.9 lbs

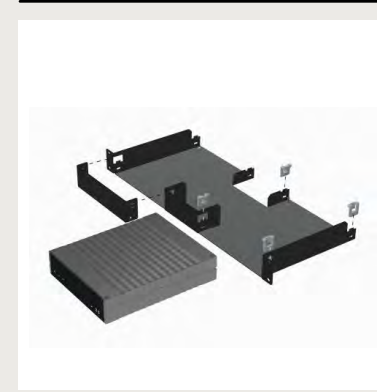

## IA-RS1 1002500010

Mounting Bracket for ICX-510/ICX-510-IA - 19"

### Used with:

- ICX-510
- ICX-510-IA

### Dimensions:

- Size (HxWxD): 1.1" x 19" x 8"
- Weight: 0.9 lbs



## IPS-AC1 1002510000

PSU for ICX-510/ICX-510-IA

### Used with:

- ICX-510
- ICX-510-IA

### Dimensions:

- Size (HxWxD): 3.55" x 1.4" x 2.15"
- Weight: 0.25 lbs

# ICX-AlphaCom



## ICX-AlphaCom - Intelligent Communication Gateway

ICX-AlphaCom is a comprehensive platform designed for integrated security communication over IP. It unifies various communication systems such as intercoms, radios, public address (PA), and telephony, and integrates these with security components like fire alarms, access control, and CCTV systems. This integration provides a streamlined and efficient communication network crucial for security and operational efficiency in various environments.

ICX-AlphaCom is a robust, scalable, and versatile solution that meets the complex communication and security needs of modern infrastructures, ensuring efficient and secure operations across different sectors.



**ICX-510-IA**  
**1002000110**  
ICX-510 incl ICX-AlphaCom Core

- Supports up to 552 IC devices per node
- State-of-the-art, quad-core processing capacity
- Dual software images for system robustness and low downtime during software upgrades
- Native API and cloud connectivity
- High-speed network ports to support multiple calls
- Large memory supports future feature expansion and new services

**Dimensions:**  
• Size (HxWxD): 1.75" x 6.4" x 7.85"  
• Weight: 2.2 lbs

For accessories please see **ICX-510 Accessories**

## ICX-AlphaCom Licenses



**ICX-Core\_x64**  
**1002600000**  
ICX-AlphaCom Core\_x64

- ICX-AlphaCom Core for x64

**ILS-IC**  
**1002600100**  
IP Station License

- Device license

**ILS-CRM**  
**1002600200**  
IP-station license, CRM

- CRM license, enables the use of DAK48 module

**ILS-SC**  
**1002600300**  
IP Station License, SoftClient

- Device license for SoftClient
- The SoftClient will turn a PC into a Zenitel Intercom, providing access to a wide set of critical communication services.

**ILS-ARIO**  
**1002600400**  
IP-ARIO Audio License - 1 IP-ARIO

- The IP-ARIO is a multi-purpose unit providing I/O and audio interfaces to radio and PA amplifiers. The audio feature requires an ILS-ARIO license, one for each IP-ARIO unit.

**ILS-AMP**  
**1002600500**  
Exigo amplifier channel license

- The ENA Amplifier Channel License allows you to connect an ENA Network Amplifier to ICX-AlphaCom over IP.



**ILS-AVC**  
**1002600600**  
Exigo AVC license

**ILS-SIP**  
**1002600700**  
SIP Station License

- Device license for connecting to 3rd party devices

**ILI-AN2**  
**1002602001**  
AlphaNet License

- AlphaNet, 2 lines
- The AlphaNet license makes it possible to establish communication between ICX-AlphaCom, AlphaCom E, and AlphaCom XE nodes in an IP network

**ILI-AN8**  
**1002602003**  
AlphaNet License

- AlphaNet, 8 lines
- The AlphaNet license makes it possible to establish communication between ICX-AlphaCom, AlphaCom E, and AlphaCom XE nodes in an IP network

**ILI-SIP2**  
**1002602101**  
SIP Trunking License

- SIP Trunking, 2 lines
- The SIP Trunking License is required to establish a SIP-trunk between ICX-AlphaCom and a 3rd party SIP-server

**ILI-SIP4**  
**1002602102**  
SIP Trunking License

- SIP Trunking, 4 lines
- The SIP Trunking License is required to establish a SIP-trunk between ICX-AlphaCom and a 3rd party SIP-server

**ILI-SIP8**  
**1002602103**  
SIP Trunking License

- SIP Trunking, 8 lines
- The SIP Trunking License is required to establish a SIP-trunk between ICX-AlphaCom and a 3rd party SIP-server

**ILI-REC2**  
**1002602201**  
Active Recording Interface License

- Active Recording Interface, 2 Users
- Allows for a SIP call session to be recorded recorded to a compatible Network Audio Recorder.

**ILI-REC8**  
**1002602203**  
Active Recording Interface License

- Active Recording Interface, 8 Users
- Allows for a SIP call session to be recorded recorded to a compatible Network Audio Recorder.

**ILI-REC16**  
**1002602204**  
Active Recording Interface License

- Active Recording Interface, 16 Users
- Allows for a SIP call session to be recorded recorded to a compatible Network Audio Recorder.

**ILI-REC32**  
**1002602205**  
Active Recording Interface License

- Active Recording Interface, 32 Users
- Allows for a SIP call session to be recorded recorded to a compatible Network Audio Recorder.

**ILI-API64**  
**1002602306**  
API License

- API License supporting 64 Stations



**ILI-API512**  
**1002602309**  
API License

- API License supporting 512 Stations

**ILI-IF**  
**1002602400**  
Interface Enabling License

- Enables the ACDP, MPC, EDO/EDI and ESPA444 interfaces.

**ILF-M-BAS**  
**1002604000**  
Audio Messaging License

- The license has the capacity to both store and play audio messages.
- Max 10 Mbyte used for the above mentioned custom audio messages

**ILF-M-ENH**  
**1002604100**  
Audio Messaging License

- The license has the capacity to both store and play audio messages.
- Max 50 Mbyte used for the custom uploadable audio messages.

**ILF-M-EXT**  
**1002604200**  
Audio Messaging License

- The license has the capacity to both store and play audio messages.
- Possibility to store messages on SD-card or USB-stick for increased storage space

**ILF-HBA**  
**1002604500**  
High bandwidth audio license

- The HD Audio license allows for high bandwidth audio streaming to distribute background music.

**ILR-U64**  
**1002606006**  
Redundancy License 64 Users

**ILR-U256**  
**1002606008**  
Redundancy License 256 Users

**ILR-U512**  
**1002606009**  
Redundancy License 512 Users

# ICX-AlphaCom Application Software

## AlphaPro

AlphaPro is the tool for configuring the ICX-AlphaCom system. It is self-contained, simple to install, and easy to use. When a new server is to be configured, the server is given a working default factory setting.

The operator can then modify the settings such as:

- Directory (type of station, line interface, display name and more)
- Define groups (cell groups, guard groups)
- Interface to CCTV, PA, Paging, DECT
- AlphaNet
- Other custom behavior

There are currently over 100 defined features that can be programmed with AlphaPro. As AlphaPro is an off-line tool, and it is possible to enter all parameters without being connected to the server. Once all parameters are entered, AlphaPro can be connected to the server and the parameters can be sent. AlphaPro can also upload configuration information from a server.

- AlphaPro connects to a server via the IP network. AlphaPro E7 runs without a hardware key. It gives access to all features except AlphaNet, but only for 36 subscribers.

AlphaPro Professional uses the Professional hardware key. It provides access to all features for all stations. This version must be used when extensive changes to the autoloader are required.



AlphaPro Professional  
1009291120  
USB Dongle

## Vingtor-Stentofon Operator

Vingtor-Stentofon Operator is a PC-based system management application package for the ICX-AlphaCom platform. It shows the status of intercom devices by way of maps and makes it easy for operators to:

- View calls and call requests
- Act easily and quickly on events and requests
- Store an on-screen history of events through a Journal

The application is primarily intended for use in a control room environment. It provides a clear overview for operators with multiple layout possibilities according to the operator's preference. Layouts can be defined to cover single or multiple screens and can be added, edited, and deleted by administrators.

## Audio Messaging

With Audio Messaging you can store and play audio messages directly from your PC or intercom station, and the messages are safely stored in the flash memory of the ICX-AlphaCom system. Audio Messaging supports a wide set of applications including auto-attendant, PA broadcasting, voice response, and voice driven menus. It is easy to initiate audio messages from 3rd party systems using OPC, SDK, or Data Protocol. Make live PA and group call broadcasts with recall for handling feedback and verifying messages. Schedule PA and group broadcasts for specific events and set up an auto-attendant with voice guided menus for handling incoming calls. You can also set up a voice response for call request waiting messages and absence messages.

## VS-Operator

1191101000  
Vingtor-Stentofon Operator Basic License

## VS-Operator

1191101010  
Vingtor-Stentofon Operator Enhanced License

## Software Development Kit

The Software Development Kit (SDK) makes it easy for 3<sup>rd</sup>-party developers to make value-added applications for integration with the ICX-AlphaCom system. The SDK is based on Microsoft .NET technology. This gives the 3<sup>rd</sup>-party developer access to a wide set of software components as well as an extensive Microsoft .NET development environment and tool set. Some examples of applications that can be made using the SDK:

- Integrated control room panel on a touch-screen for public address, radio and intercom
- Interactive intercom icons on a map with ability to call, broadcast public address, and listen in
- Integration with video analytics to provide voice response if someone is trespassing
- Integration with CCTV, where a camera is switched on with Voice Activity Detection
- PC-based Call Handler with graphical user interface for control rooms and guards

The SDK consists of a number of assemblies (DLLs) that can be easily integrated with software written in C#.

To further support 3<sup>rd</sup>-party developers, help files, a quick start manual, Wiki pages and example applications including source code are available to get you quickly up to speed with writing value-added applications for the ICX-AlphaCom system.

To get access to the SDK, please visit: [www.zenitel.com/sdk-alphacom](http://www.zenitel.com/sdk-alphacom)

## OPC

OPC provides easy and fast integration based on standard OPC technology. OPC is licensed by the ILLI-API64 and ILLI-API512 licenses.

The ICX-AlphaCom OPC Server implements the following OPC standards:

- OPC Data Access (OPC DA V2/V3)
- OPC Alarm & Events (OPC AE V1.1)
- OPC Unified Architecture (OPC UA)

## VS Recorder

- ICX-AlphaCom Call Recording
- Audio and Video Stream Recording

The VS Recorder software is a fully-featured IP based audio recorder with additional support for video recording. The solution is able to record calls from all types of terminals connected to ICX-AlphaCom: IP intercoms and IP phones. The Recorder is also a NAVR – Network Audio/Video Recorder.

## VS-Recorder

1190110100  
VS Recorder Software - Base Module

## VS-Recorder

1190110110  
VS Recorder Software - Playback/Configuration Client

## VS-Recorder

1190110120  
VS Recorder Software - AlphaCom Recording Module

## VS-Recorder

1190110121  
VS Recorder Software - AlphaCom Recording Module, AddOn

## VS-Recorder

1190110131  
VS Recorder Software - Stream Recording Module, 1 stream

## VS-Recorder

1190110138  
VS Recorder Software - Stream Recording Module, 8 streams

## VS-Recorder

1190110160  
VS Recorder Software - API

## VS-Recorder

1190110180  
VS Recorder Software - Secure Audio Export

# Analog Stations

## Analog Stations only work with AlphaCom

For **Accessories**, please see **Audio and Video Intercom Accessories** unless otherwise specified under the product.

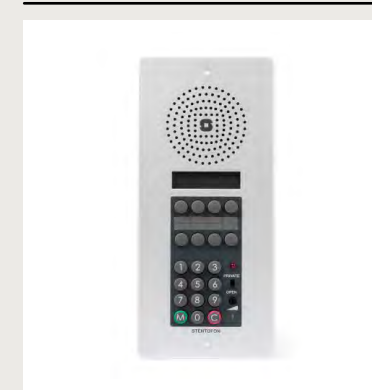

Wall Master Station  
**1007042000**  
With Display

- 8 programmable DAK keys
- 'Microphone live' indicator
- Private/Open switch

**Accessories:**  
Requires 1000602000 Flush Mount Back Box,  
or 1000603000 On Wall Back Box

**Dimensions:**

- Size (HxWxD): 11" x 4.9" x 2.1"
- Weight: 1.8 lbs

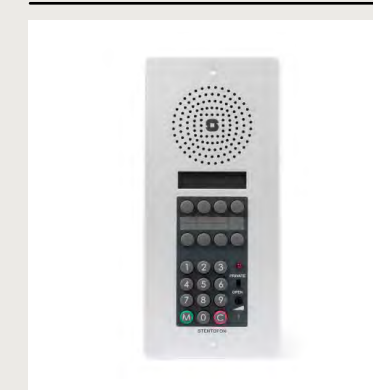

Wall Master Station  
**1007040000**  
Standard

- 'Microphone live' indicator
- Private/Open switch

**Accessories:**  
Requires 1000602000 Flush Mount Back Box,  
or 1000603000 On Wall Back Box

**Dimensions:**

- Size (HxWxD): 11" x 4.9" x 2.1"
- Weight: 1.8 lbs



Dual Display Station  
**1007007000**  
Analog Desktop Master Station

- Up to 90 programmable DAK keys
- Four navigation keys for quick access to system menus and directory entries

**Accessories:**  
1009800130 Station Cable with RJ45  
1007007010 Microphone

**Dimensions:**

- Size (HxWxD): 5.5" x 2.8" x 10.6"
- Weight: 0.9 lbs

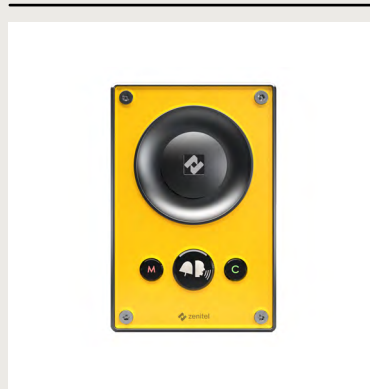

TCAS-1  
**1008114010**  
Analog Intercom

- LED lit call button, and two PTT buttons  
M (manual speech) and C (cancel)
- Analog MEMS microphone

IP66 IK08

**Dimensions:**

- Size (HxWxD): 7.1" x 4.7" x 0.9"
- Weight: 2.2 lbs

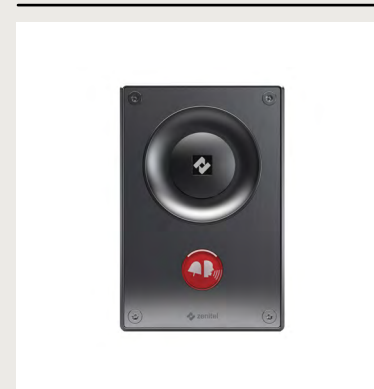

TCAS-2  
**1008114020**  
Analog Intercom

- LED lit call button
- 3mm stainless steel faceplate
- Analog MEMS microphone

IP66 IK10

**Dimensions:**

- Size (HxWxD): 7.1" x 4.7" x 0.9"
- Weight: 2.2 lbs

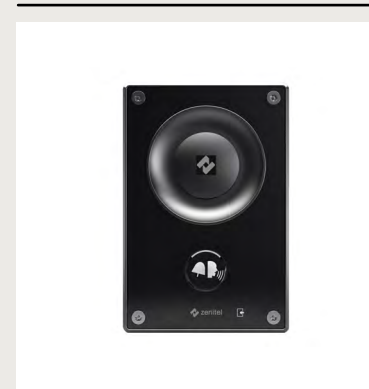

TCAS-3  
**1008114030**  
Analog Intercom

- LED lit call button
- Door open LED indicator
- Analog MEMS microphone

IP66 IK08

**Dimensions:**

- Size (HxWxD): 7.1" x 4.7" x 0.9"
- Weight: 2.2 lbs

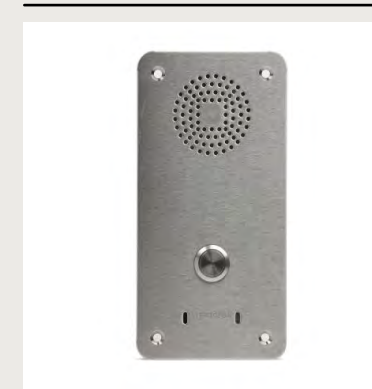

Vandal Resistant Substation  
**1007056100**  
Analog Vandal Resistant Substation

- One call button with option for external or extra button
- LED lit call indication
- 2mm stainless steel frontplate

IP55 IK08

**Dimensions:**

- Size (HxWxD): 7.1" x 3.6" x 1"
- Weight: 1.8 lbs

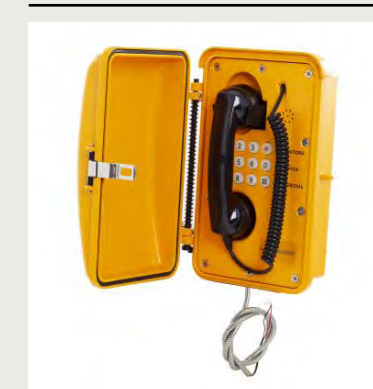

KNSP-01  
**2213000200**  
Heavy-Duty Telephone with Door

- 5mm aluminum casing
- Door with smart stay-open / stay-shut mechanism
- Stores up to 10 speed-dial numbers
- Powered by phone line

IP66

**Dimensions:**

- Size (HxWxD): 8.1" x 12.6" x 5.5"
- Weight: 11.9 lbs

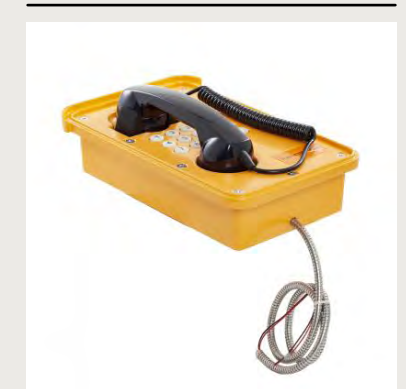

KNSP-09  
**2213000100**  
Heavy-Duty Telephone

- 5mm aluminum casing
- Magnetic reed hook-switch gives minimal tear and wear
- Stores up to 10 speed-dial numbers
- Powered by phone line

IP66

**Dimensions:**

- Size (HxWxD): 8.1" x 12.6" x 4.7"
- Weight: 11 lbs

# Licenses

## IC-EDGE Licenses



IC-EDGE Station License  
**1009661001**  
1x IC-EDGE-IP Station License

IC-EDGE SIP  
**1009661201**  
1x IC-EDGE-SIP-Client Extensions

IC-EDGE TelTrunk  
**1009662001**  
IC-EDGE TelTrunk

## AlphaCom XE Licenses

IP stations require a license. They do not require additional hardware such as an ASLT card. The maximum number of stations that is supported by AlphaCom XE Audio Servers is 552.

IP station license  
**1009641001**  
IP station license for 1 station

IP station license  
**1009641006**  
IP station license for 6 stations

SoftClient  
**1009648012**  
Vingtor-Stentofon Softclient - 6 Licenses

CRM-V DAK expansion  
**1009648001**  
License for CRM-V DAK expansion

SoftClient  
**1009648011**  
Vingtor-Stentofon Softclient - 1 License

**AlphaNet** and multi-module linking for the AlphaCom XE Audio Servers can be via data networks. This does not require additional hardware inside the server, but opening up the capability requires the correct license. Licenses are required in all connected modules and nodes. There is no difference whether a license is used for an AlphaNet or a multi-module connection. A static license means that the destination of an audio link needs to be defined at commissioning, a dynamic link is a common resource, and can be used for any audio link that requires connection. The data links between modules and nodes are not licensed.

**SIP Trunking** gives the possibility to connect ICX-AlphaCom to a telephone network, either directly to a SIP enabled telephone system or through a gateway to an analog or ISDN (BRI or PRI) system.

### Audio Messaging Licenses

Alphanet and Multi-Module  
**1009640002**  
AlphaNet and Multi-Module VoIP License for 2 Static Lines

Alphanet and Multi-Module  
**1009640008**  
AlphaNet and Multi-Module VoIP License for 8 Dynamic Lines

Alphanet and Multi-Module  
**1009640016**  
AlphaNet and Multi-Module VoIP License for 16 Dynamic Lines

Alphanet and Multi-Module  
**1009640030**  
AlphaNet and Multi-Module VoIP License for 30 Dynamic Lines

Alphanet and Multi-Module  
**1009640108**  
AlphaNet and Multi-Module VoIP License for 8 Dynamic Lines, upgrade from 2 lines

SIP Trunking License  
**1009642001**  
SIP Trunking, 1 Line

SIP Trunking License  
**1009642002**  
SIP Trunking License for 2 lines

SIP Trunking License  
**1009642004**  
SIP Trunking License for 4 lines

Audio Messaging  
**1009648500**  
Basic Audio Messaging License

Audio Messaging  
**1009648501**  
Enhanced Audio Messaging License

Audio Messaging  
**1009648502**  
PA Recall License

The multi-module license gives the possibility to expand the size of an Audio Server. It is possible to add up to 4 modules in a multi-module Audio Server. The modules will be linked together over a local area IP network (LAN). 30 VoIP channels are available in each server module. Note that the license is only required in the master module in the multi-module server.

Multi-Module VoIP License  
**1009640204**  
Multi-Module VoIP license - 4 Modules

SIP Trunking License  
**1009642008**  
SIP Trunking License for 8 lines

SIP Trunking License  
**1009642016**  
SIP Trunking License for 16 lines

SIP Trunking License  
**1009642104**  
SIP Trunking, 4 Lines - Upgrade from 2 Lines

• License requires AMC IP v11 hardware. Includes Delayed PA broadcast using recall to prevent feedback problems, 1 auto-attendant message, 2MB memory storage for audio messages.

• License requires AMC IP v11 hardware. Includes Delayed PA broadcast using recall to prevent feedback problems, 3 auto-attendant messages, 10MB memory storage for audio messages, Full ASVP functionality.

• License can be installed on both AMC IP v10 and v11 hardware. Includes Delayed PA broadcast using recall to prevent feedback problems.

Each **SIP** telephone requires a SIP station license. SIP telephones can be physical units but also SIP softphone clients on a PC or PDA.

#### ICX-AlphaCom Mode Licenses for Exigo Amplifiers

Each amplifier channel consumes one license, but two channels can be combined into one on an amplifier to save on licensing.

#### OPC Interface Licenses

#### Active Recording Interface Licenses

SIP station license  
**1009643001**  
SIP station license for 1 SIP telephone

Exigo Amplifier  
**1009641701**  
Exigo Amplifier Channel License for 1 Channel

Exigo Amplifier  
**1009641706**  
Exigo Amplifier Channel License for 6 Channel

API License  
**1009649901**  
API interface supporting 40 stations

API License  
**1009649902**  
API interface supporting 80 stations

API License  
**1009649903**  
API interface supporting 160 stations

API License  
**1009649904**  
API interface supporting 240 stations

Active Recording Interface  
**1009648092**  
Active recording interface - 2 users

Active Recording Interface  
**1009648093**  
Active recording interface - 6 users

Active Recording Interface  
**1009648094**  
Active recording interface - 12 users

Active Recording Interface  
**1009648095**  
Active recording interface - 36 users

SIP station license  
**1009643006**  
SIP station license for 6 SIP telephones

High Bandwidth Audio  
**1009648510**  
High Bandwidth Audio License

API License  
**1009649905**  
API interface supporting 320 stations

API License  
**1009649906**  
API interface supporting 400 stations

API License  
**1009649907**  
API interface supporting 552 stations

Active Recording Interface  
**1009648096**  
Active recording interface - 72 users

Active Recording Interface  
**1009648097**  
Active recording interface - 138 users

Active Recording Interface  
**1009648098**  
Active recording interface - 276 users

Active Recording Interface  
**1009648099**  
Active recording interface - 552 users

# Notes



Learn more  
about Zenitel  
products and  
solutions

